

110_MODERN

design: Gianluigi Landoni



IT_Descrizione prodotto

Divani, divani componibili, chaises longues, pouf, cuscino schienale pouf

Caratteristiche tecniche

Struttura: massello di pioppo e supporti in ferro per schienali e base

Molleggio: nastri elastici unidirezionali ad alta portata

Imbottitura: poliuretano espanso ricoperto con resinato accoppiato vellutino

Cuscini seduta: inserto in poliuretano espanso avvolto da materassina in piuma con fodera a sezioni separate

Cuscini schienale: piuma lavata e sterilizzata con fodera a sezioni separate e con tampone interno in poliuretano espanso.

Cuscini poggiatesta: fibra poliestere siliconata ricoperta da fodera in cotone 100%

Piedi: metallo nickel nero o con puntale verniciato ottone

Rivestimento: rivestimento in tessuto o in pelle. Rivestimento in tessuto completamente sfoderabile

Note particolari

Schienale e braccioli smontabili. Alla consegna i piedi sono smontati

EN_Product description

Sofas, unit sofas, chaises longues, ottoman, ottoman back cushion

Technical features

Frame: solid poplar wood and iron supports for back and frame

Springing: high resistance unidirectional elastic bands

Padding: polyurethane foam covered with heated bonded polyester fibre

Seat cushions: core in polyurethane foam covered with a feather layer in separate sections

Back cushions: core in polyurethane foam covered with a feather layer in separate sections

Backrest cushions: silicone polyester fibre covered with 100% cotton lining

Feet: black nickel steel or with brass tip

Cover: fabric or leather. Fabric cover completely removable

Special notes

Backrest and arms can be disassembled. Sofas are delivered with disassembled feet

Piedi / Feet



_nickel nero
_black nickel

Puntale / Tips



_ottone
_brass

Vibieffe

SINCE 1968

contact@vibieffe.com www.vibieffe.com

110_MODERN

design: Gianluigi Landoni

- B - Espanso densità portante / Foam supporting density
- C - Espanso densità soft / Foam soft density
- L - Fusto in legno / Wooden frame
- P - Piuma / Feather
- R - Resinato / Heated bonded polyester fibre
- S - Fibra poliestere siliconata / Silicone polyester fibre

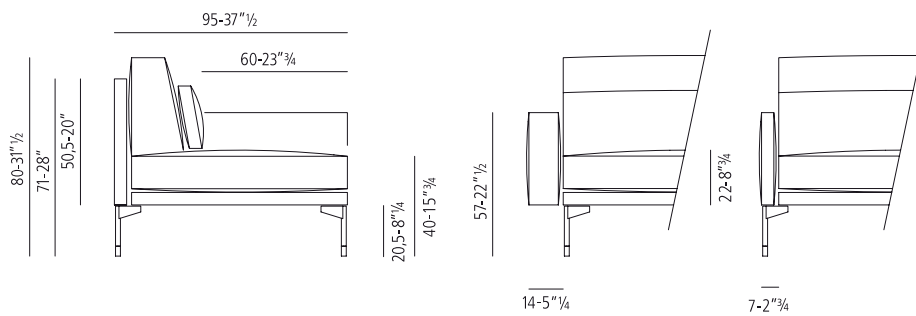
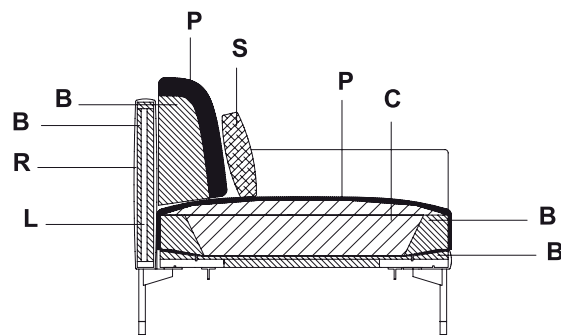

Vibieffe

SINCE 1968

contact@vibieffe.com www.vibieffe.com

110_MODERN

design: Gianluigi Landoni

cod. I10001

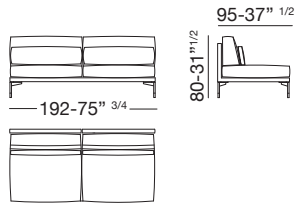

cod. I10002

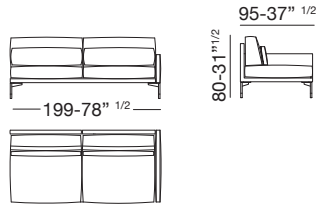

cod. I10003

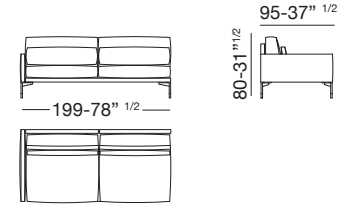

cod. I10004

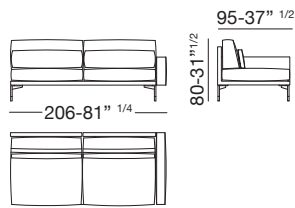

cod. I10005

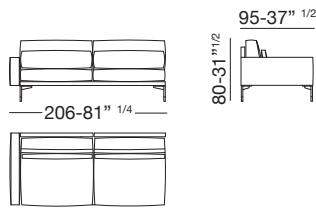

cod. I10012

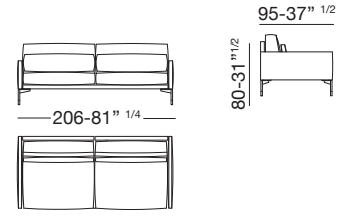

cod. I10013

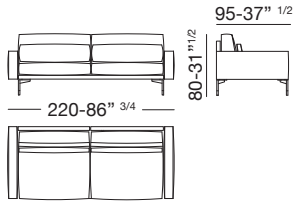

cod. I10014

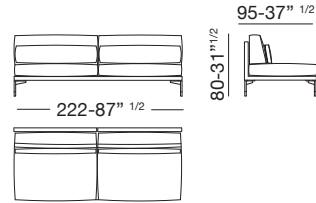

cod. I10015

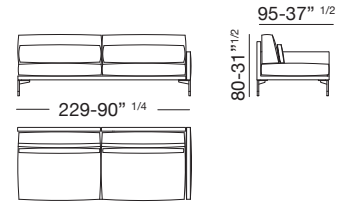

cod. I10016

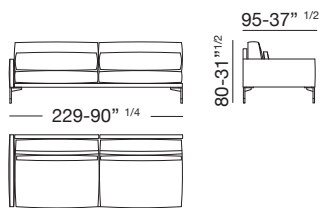

cod. I10017

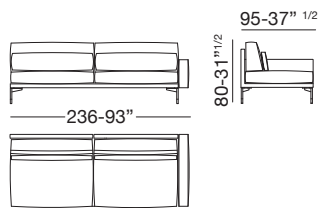

cod. I10018

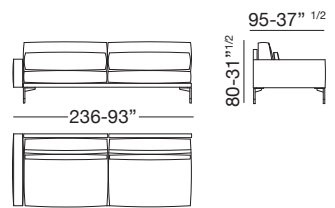

cod. I10025

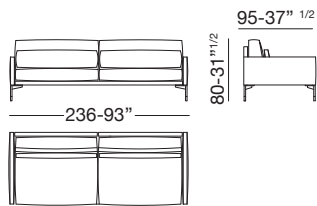

cod. I10026

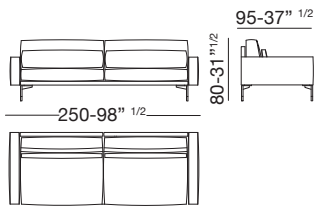

cod. I10027

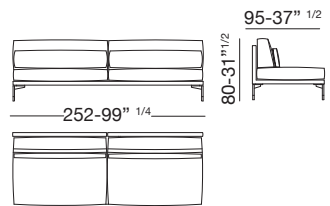

Vibieffe

SINCE 1968

contact@vibieffe.com www.vibieffe.com

110_MODERN

design: Gianluigi Landoni

cod. 110028

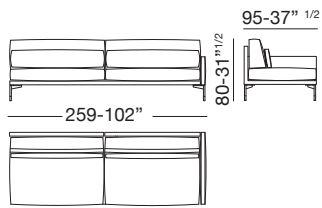

cod. 110029

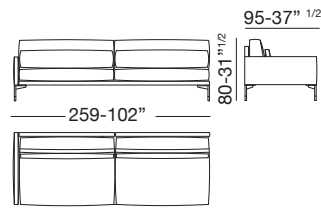

cod. 110030

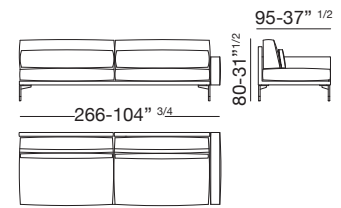

cod. 110031

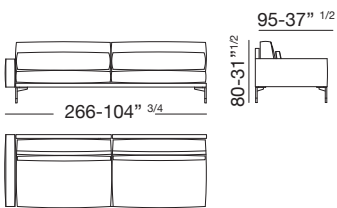

cod. 110038

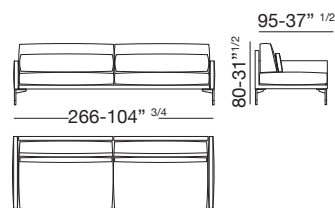

cod. 110039

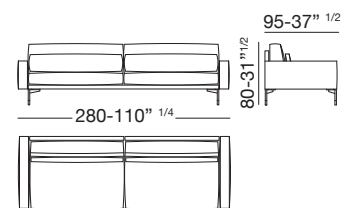

110_MODERN

design: Gianluigi Landoni

cod. I10047

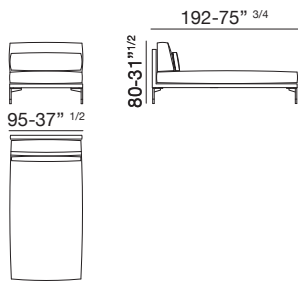

cod. I10048

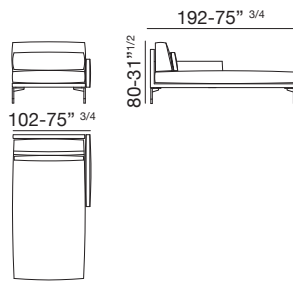

cod. I10049

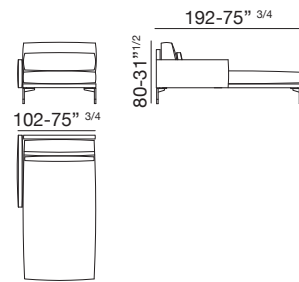

cod. I10050

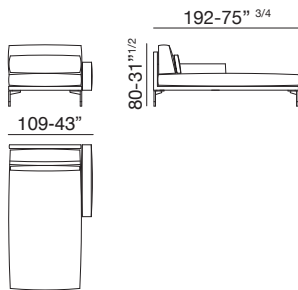

cod. I10051

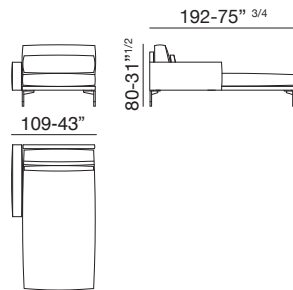

110_MODERN

design: Gianluigi Landoni

cod. 110042

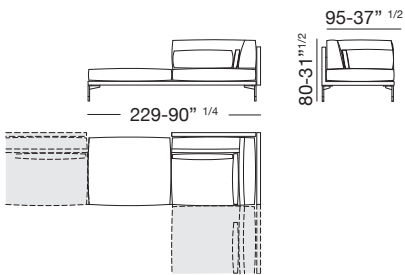

cod. 110043

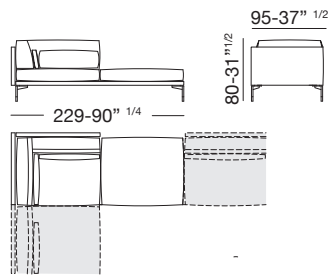

cod. 110061

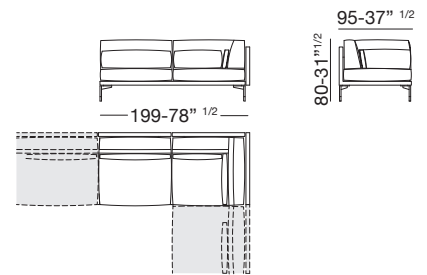

cod. 110062

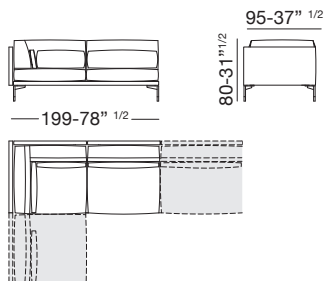

cod. 110063

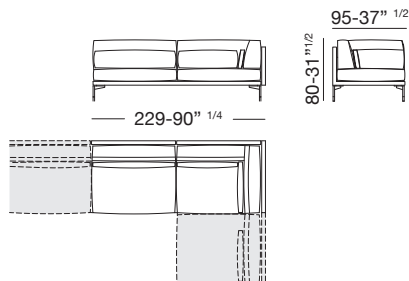

cod. 110064

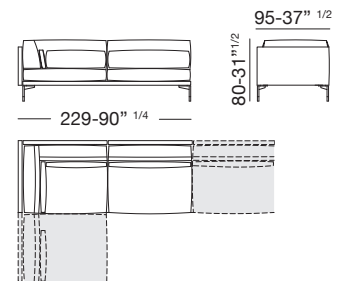

cod. 110065

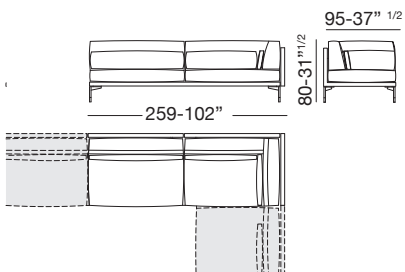

cod. 110066

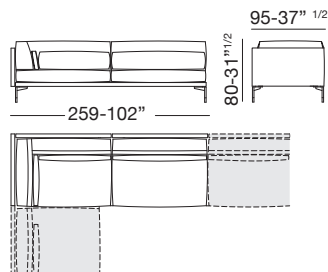

110_MODERN

design: Gianluigi Landoni



Vibieffe

SINCE 1968

contact@vibieffe.com www.vibieffe.com