



IT_Descrizione prodotto

Poltroncina, divani

Caratteristiche tecniche

Struttura: telaio in multistrato di pioppo con struttura portante in metallo

Molleggio: nastri elastici unidirezionali ad alta portata

Imbottitura: poliuretano espanso a quote differenziate e memory ricoperto in termolegato cotone 100%

Cuscini schienale: fibra poliestere siliconata ricoperta da fodera in cotone 100%

Piedi o braccioli: massello in noce canaletto o rovere tinto moka

Rivestimento: rivestimento in tessuto o in pelle non sfoderabile

Finitura rivestimento: trapuntatura con cordolo nero

Note particolari

All'ordine specificare finitura piedi o braccioli.

I cuscini schienale non sono compresi nel costo dei divani.

EN_Product description

Small armchair, sofas

Technical features

Frame: poplar plywood framework with a metal support structure

Suspensions: high tensile unidirectional elastic bands

Padding: polyurethane foam with different densities and memory foam wrapped in a thermal bonded 100% cotton fiber

Backrest cushions: silicone polyester fiber wrapped in a 100% cotton lining.

Feet or armrests: solid Canaletto walnut wood or moka dyed oak.

Covers: fabric or leather, non-removable

Cover finishes: quilted with black profiles

Special notes

Please specify feet or arms finishing.

Back cushions are not included in the sofas price.

Piedi o braccioli / Feet or armrests



_noce canaletto
_canaletto walnut



_legno laccato nero opaco
_black opaque lacquered wood

Vibieffe

SINCE 1968

contact@vibieffe.com www.vibieffe.com

- A - Espanso densità por tante / High density foam
- B - Espanso densità media / Medium density foam
- C - Espanso densità soft / Soft density foam
- D - Memory foam / Memory foam
- E - Fusto in legno / Wooden frame

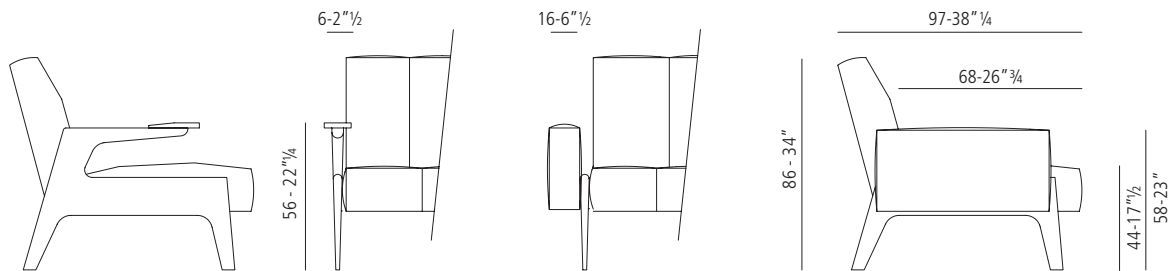
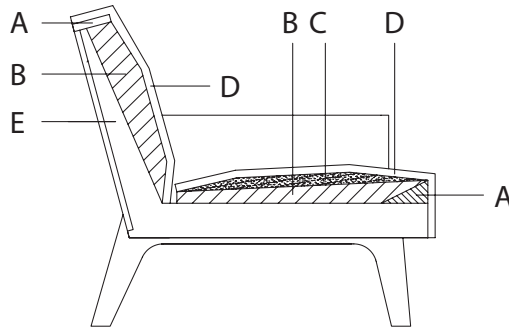

Vibieffe

SINCE 1968

contact@vibieffe.com www.vibieffe.com

cod. 50001

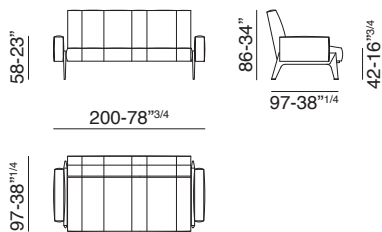

cod. 50002

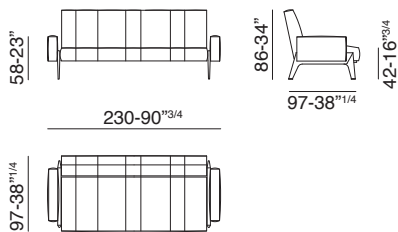

cod. 50003

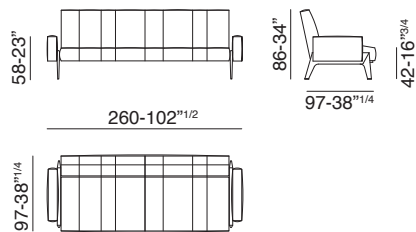

cod. 50004

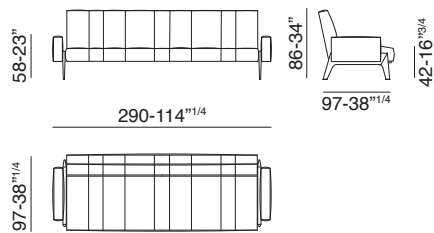

cod. 50006

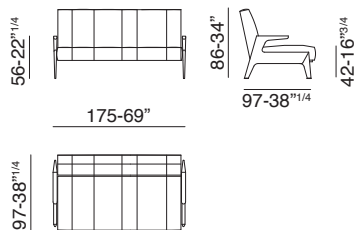

cod. 50007

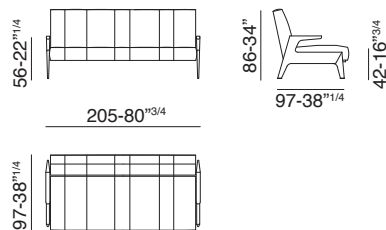

cod. 50008

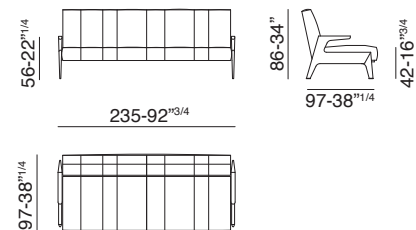

cod. 50009

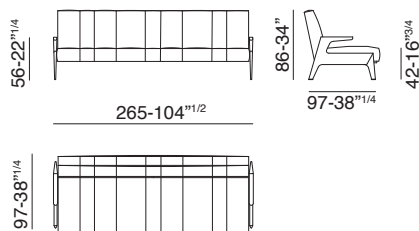

cod. 50010

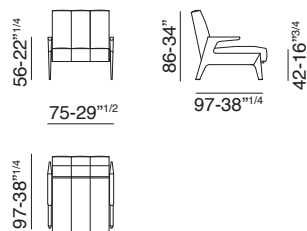

cod. 50005

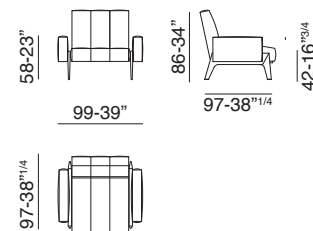



Vibieffe

SINCE 1968

contact@vibieffe.com www.vibieffe.com