

PRICE LIST_2024



Vibieffe

SINCE 1968

Condizioni di vendita / Terms of sale	03
Collezione tessuti / Fabric collection	07

DIVANI / SOFAS

25	Lane	14
35	Waves	19
50	Italo	25
85	Shell	28
110	Modern	37
120	Modern_Air	44
150	Feel	48
160	Re-Feel	56
200	Cube	61
275	Glam	66
310	Identity	72
360	Confident	76
370	Bolid	79
400	Senza_Tempo	81
430	Opera	87
470	Fancy	90
525	Nordic	94
535	Sit_Up	100
550	Altopiano	107
575	Hi_Story	112
580	Re_Set	114
650	Nido	117
680	Class	119
810	Fly	122
845	Evo	135
910	Zone Slim	144
920	Zone Comfort	150

POLTRONE / ARMCHAIRS

50	Italo	27
430	Opera	88
650	Nido	118
680	Class	120
1000	Fast	158
1355	Timeless	159
1390	Essence	160
1650	Cordi	161
1950	Atmosfera	162

PANCHE / BENCH

150	Feel	166
415	Tube	168
9300	Pancake	169

DIVANI LETTO / SOFABEDS

2020	Squadroletto	172
2110	Tank	175
2300	Queen	177
2400	Happy	179
2505	Desigual	181
2750	Surprise	183
2800	Bel Air	185
2900	Open	188
3600	Tangram	190
3700	Gulp	192

LETTI-ACCESSORI / BEDS-COMPLEMENTS

1500	Swing - Accessori	196
5050	Italo - Accessorio	198
5555	Modern - Accessori	199
9575	Xenia - Accessori	201
9750	Contraste - Accessorio	203
5000	Queen	204
5050	Italo	205
5115	Modern_Epoque	206
5300	Open	208
5400	Tangram	209
5500	Soap	210
5700	Opera	211
5800	Tube	212
5800	Tube - Accessorio	213
	Materassi / Mattresses	214

COMPLEMENTI / ACCESSORIES

314	A_Round	216
1280	Pavilion	217
1500	Swing	218
9020	Point	220
9085	Concrete	221
9150	Quadri_Tondo	222
9200	Pico	225
9235	Chignon	226
9350	Him & Her	227
9517	Abaco	228
9598	Essential	229
9595	Form	230
9563	Glowly	231
9568	Nice	232
9528	Self	233
9575	Xenia Consolle	234
9600	Cuscini	235

LIBRERIE - MADIE / BOOKCASES - SIDEBOARDS

9730	Profile	238
9810	Next	239
9900	E_Spirit	240
9950	Street	241

SEDIE - TAVOLI / CHAIRS - TABLES

430	Opera	244
1500	Swing	246
4000	Royal	248
4050	Italo	250
4150	Twist	252
4200	Circle	254

LAMPADE / LAMPS

7000	Lampade / Lamps	256
7000	Lampada Big	261
9810	Next_Lampada	262

TAPPETI / CARPETS

8000	Carpet	264
------	--------	-----

CONDIZIONI DI VENDITA / TERMS OF SALE / VERKAUFSBEDINGUNGEN / CONDITIONS DE VENTE

CONSEGNA

Le date di consegna riportate in conferma d'ordine sono puramente indicative e non sono vincolanti. Si esclude pertanto qualsiasi indennizzo per eventuali ritardi.

TERMS OF DELIVERY

The terms of delivery mentioned in the order confirmation are only indicative and not binding. Thus, any compensation for delays is excluded.

LIEFERZEIT

Die in der Auftragsbestätigung angegebenen Liefertermine sind rein indikativ und nicht bindend. Jede Entschädigung für eventuelle Verspätungen wird also ausgeschlossen.

DELAIS DE LIVRAISON

Les dates de livraison indiquées dans la confirmation de commande sont purement indicatives et non contraignantes. Aucune indemnisation de retard ne sera accordées.

RESA

Merce resa franco magazzino Cliente o franco fabbrica. Per ordinativi inferiori a Euro 1000 netto sarà addebitato un importo a forfait di Euro 80. L'imballo in scatola di cartone è gratuito.

DELIVERY

Delivery Ex-works or included according to the sales conditions agreed. For orders below 1000 euro net, we will charge a lump-sum of 80 Euro. Carton packaging free of charge.

ÜBERGABE

Die Ware wird frei Kundenlager oder ab Werk geliefert, bei Auftragswerten unter Euro 1000 netto wird ein Pauschalbetrag von Euro 80 berechnet. Kartonverpackung gratis.

LIVRAISON

Marchandise livrée franco domicile ou départ usine. Pour les commandes inférieures à Euro 1000 net, la somme forfaitaire de Euro 80 sera ajoutée au prix. L'emballage en carton est gratuit.

Imballi legno - Wooden packaging - Holzkiste - Emballage en bois

<i>Peso / Weight / Gewicht / Poids</i> <i>Kg.</i>	<i>Scatola / Box / Kiste / Boîte</i>	<i>Prezzo / Price / Preis / Prix</i>
67,2	< = cm 100	476
84,0	< = cm 150	585
100,8	< = cm 200	693
117,6	< = cm 250	856
134,4	< = cm 300	987

Volume: + 10% da volume listino / + 10% from the volume stated in the price list
+ 10% als in der Preisliste angegeben / + 10% du volume mentionné sur le liste de prix

Il presente listino prezzi (1 Luglio 2024) annulla e sostituisce tutte le quotazioni in Vostro possesso. I prezzi sono espressi in Euro, esclusi IVA.

This price list (1st July 2024) cancels and replaces any previous quotation. Prices are in Euro, VAT excluded.

Diese Preisliste (1. Juli 2024) annulliert und ersetzt jede vorherige Notierung in Ihrem Besitz. Die Preise sind in Euro, o. Mehrwertsteuer.

Ce tarif (1 Juillet 2024) annule et remplace tous les tarifs précédents en votre possession. Les prix sont exprimés en Euro, HT.

RECLAMI

I reclami dovranno essere inoltrati entro otto giorni dal ricevimento della merce, pena la decadenza di ogni diritto. Qualora il reclamo sia stato tempestivo e risulti fondato, il nostro obbligo è limitato alla sostituzione della merce non conforme, escludendosi qualsiasi diritto del Compratore di richiedere la risoluzione del contratto, la riduzione del prezzo e, in ogni caso, il risarcimento di eventuali danni ed il rimborso delle spese sostenute a qualsiasi titolo. I reclami non danno diritto al Compratore di sospendere il pagamento della fattura relativa alla merce contestata. Eventuali difetti di fabbricazione riconosciuti a noi imputabili, previo nostro accertamento, daranno diritto al Compratore unicamente al ripristino o, a discrezione di questa Società, alla sostituzione totale o parziale dell'elemento e non daranno diritto al Compratore al risarcimento di eventuali danni ed al rimborso delle spese sostenute a qualsiasi titolo.

Al momento della consegna della merce da parte dello spedizioniere firmare sempre i documenti per ricevuta con riserva di controllo pena la nullità della garanzia per danni di trasporto.

CLAIMS

Any claim must be forwarded within eight days after receipt of the goods, otherwise it cannot be accepted. After this deadline Vibieffe shall be entitled to refuse any claim. If the claim is accepted, our obligation is to change the faulty item only. It is excluded any right of the buyer to ask for the cancellation of the contract or for any discount, without giving any right of compensation of any damages or additional expenses and the payment of the claimed goods cannot be withheld. Any manufacturing defect acknowledged by our company will give the buyer the right of receiving the total or partial change of the faulty element only. Upon delivery of the goods, always sign the documents for reception writing "goods unchecked" otherwise the warranty for transport damages will be considered null and void.

BESCHWERDEN

Beschwerden müssen binnen acht Tagen nach Erhalt der Ware angemeldet werden, da sonst jeder Rechtsanspruch verfällt. Falls die Reklamation rechtzeitig ankommt und berechtigt sein sollte, schließt sich unsere Pflicht mit dem Ersatz der mangelhaften Ware ab; jedes Recht des Käufers auf Auflösung des Vertrages, auf Preisermäßigung und auf jeden Fall auf den Ersatz der eventuellen Schäden und auf Auslagerersatz jeder Art zu verlangen, wird ausgeschlossen. Beschwerden geben dem Käufer nicht das Recht, die Zahlung der die reklamierte Ware betreffenden Rechnung einzustellen. Eventuelle anerkannte Fabrikationsfehler, die nach Feststellung unsererseits uns zuzuschreiben sind, geben dem Käufer einzig das Recht zur Wiederherstellung oder, je nach Entscheidung unserer Firma, zum vollständigen oder Teilersatz des Elements und werden dem Käufer kein Recht auf Ersatz der eventuellen Schäden und auf Auslagerersatz jeder Art geben.

Bei dem Wareneingang, im Zusammenhang mit der Quittierung des Warenerhalts, unterschreiben Sie bitte immer den Frachtbrief, unter Vorbehalt einer späteren Kontrolle, da wir und die Spedition sonst keine Haftung für Transportschäden übernehmen werden.

RECLAMATIONS

Toute réclamation doit être effectuée dans un délai de huit jours après réception de la marchandise. Dans le cas contraire, tous droits seront déçus. Si la réclamation a été effectuée à temps et acceptée par notre Société, notre obligation se limite au remplacement de la marchandise avec exclusion de tous droits pour l'acheteur de réclamer la résiliation du contrat d'une réduction de prix ou du le remboursement de frais supplémentaires. Les réclamations ne donnent pas à l'acheteur le droit de suspendre le paiement de la facture relative à la marchandise en cause. Les défauts de fabrication qui seront reconnus et acceptés par notre Société ne donneront pas le droit à l'acheteur d'obtenir un remboursement de quelque nature que ce soit.

Lors de la livraison de la marchandise toujours signer les documents pour la réception sous réserve de vérification sinon la garantie pour les dommages de transport sera déclarée entachée de nullité.

AVVERTENZE IMPORTANTI

In caso di completamento dell'ordine in tempo successivo, non si garantisce l'uguaglianza del tessuto e della pelle tra la composizione iniziale e gli elementi aggiunti. Il risultato del completamento è quindi a totale rischio del Cliente. I prodotti rivestiti in pelle sono parzialmente sfoderabili, solo la scocca del divano viene fissata per una migliore riuscita del prodotto.

Nel caso di ordini con tessuti appartenenti a diverse categorie, si applicherà il prezzo della categoria superiore.

Nel caso di ordini con diversi tessuti nella stessa categoria si applicherà un supplemento prezzo pari al 5%.

Nel caso di ordini con tessuto in colore fuori campionario, sarà addebitato supplemento di EURO 22 al metro lineare.

Prima dell'invio di tessuti Cliente con rapporto: disegni in genere, spessori ecc., consultare la Vibieffe per l'esatto metraggio da inviare.

Su questa lavorazione, per supplemento di manodopera, verrà applicata una maggiorazione del 7% rispetto al prezzo indicato in listino sulla categoria tessuto Cliente. I tessuti di proprietà Cliente che ci saranno inviati per la ricopertura dei modelli di nostra produzione, dovranno pervenirci in porto franco.

I colori dei tessuti e delle pelli inseriti nel campionario sono indicativi.

Per il lavaggio dei tessuti in campionario attenersi alle istruzioni riportate nel campionario stesso. Su richiesta, la Vibieffe, può prendersi cura del prelavaggio dei nostri tessuti, con addebito. Una colonna apposita, nell'elenco COLLEZIONE TESSUTI (da pagina 7 a pagina 10) segnala dove è possibile effettuare questo trattamento.

Senza alcun preavviso la Vibieffe si riserva il diritto di apportare modifiche tecniche sui prodotti.

IMPORTANT REMARKS

If the order is completed at subsequent times, we cannot assure that the dye lots of the fabric and leather used for the initial composition will be the same of the added elements. Therefore, the final result is at Customer's sole risk.

Leather covers can be partially removed: only the base of the sofa is fixed for a better outcome of the product.

For orders with fabrics in different categories, the price of the higher category will be applied.

For orders with different fabrics in the same category, a 5% surcharge on the standard price will be applied.

Should you order a fabric in a colour which is not in our collection, a 22 euro charge for each linear meter will be applied.

Before sending COMs with repeat, please consult Vibieffe for the exact qty needed according to the pattern, thickness, etc. A 7% price list surcharge will be applied to COM price category, because of the extra handwork required. COMs have to be sent Ex-works.

Fabric and leather colours included in the sample book are indicative.

Please follow the instructions on the back of each sample to wash the fabrics in collection. Vibieffe can carry out the prewash treatment of our fabrics upon request at an additional charge. An appropriate column in the FABRIC COLLECTION list (from page 7 to page 10) specifies if this treatment can be carried out.

Vibieffe reserves the right to introduce technical modifications to the products without any prior notice.

WICHTIGE HINWEISE

Sollte der Auftrag in einer darauffolgenden Zeit vervollständigt werden, wird das Gleichsein des Stoffes und des Leders der Anfangszusammenstellung mit dem der hinzugefügten Elemente nicht versichert. Das Ergebnis der kompletten Zusammenstellung erfolgt also auf Gefahr des Kunden. Die mit Leder überzogenen Modelle sind nur teilweise abnehmbar; nur der Bezug des Korpus ist fest verpolstert.

Bei Aufträgen von Stoffen, die zu unterschiedlichen Kategorien gehören, wird der Preis der nächst höheren Kategorie verrechnet.

Bei Aufträgen von verschiedenen Stoffen in der gleichen Kategorie wird ein Mehrpreis von 5% kalkuliert.

Im Falle von Bestellungen mit einer Stofffarbe nicht in unserer Kollektion, wird ein Aufpreis von EURO 22 pro lmt kalkuliert.

Bevor Sie Kundenstoffe mit einem Muster einsenden: Stoffe mit einem Rapport, besonders dick usw., fragen Sie bei Vibieffe die exakte Menge an. Um diese Stoffe zu bearbeiten, muss man mit einem Aufschlag von 7% auf die Kundenstoffkategorie der Preisliste wegen des Aufwandes unserer Arbeitskraft rechnen.

Die Kundenstoffe, die Eigentum des Kunden sind und die für die Bearbeitung von Modellen in unserer Kollektion bestimmt sind, müssen an uns frei Haus geliefert werden.

Die Farben der Stoffe und Leder der Mustersammlung sind rein indikativ.

Wasch- bzw. Reinigungsanleitungen für die Stoffe in Kollektion finden Sie in unserer Stoffkollektion. Auf Anfrage und kostenpflichtig kann Vibieffe das Vorwaschen unserer Stoffe durchführen. Eine besondere Spalte in der Liste der, STOFFKOLLEKTION, (S. 7 bis 10) zeigt, wo diese Behandlung möglich ist.

Vibieffe behält sich das Recht vor, technische Änderungen an den Produkten ohne Voranzeige einzuführen.

REMARQUES IMPORTANTES

Si la commande est complétée ultérieurement, la concordance entre le tissu et le cuir de la première composition avec ces éléments ajoutés ne peut pas être assurée. Le résultat du complément est donc au risque du client. Les produits revêtus en cuir peuvent être déhousés partiellement : seule la structure du canapé est fixée pour une meilleure réussite du produit.

Dans le cas des commandes avec tissus appartenants à des catégories différentes, on utilisera le prix de la catégorie supérieure. Dans le cas de commandes avec tissus différents appartenant à la même catégorie, on considerera un supplément de prix du 5%.

En cas de commandes avec une couleur de tissu pas dans notre collection on va vous charger avec un supplément de EURO 22 à mt linéaire.

Avant d'envoyer les tissus du client avec des rapports, dessins en général, épaisseurs etc., Veuillez consulter Vibieffe pour connaître le métrage exacte à envoyer. Sur cette fabrication, pour supplément de main-d'oeuvre, il sera appliqué une augmentation du 7% au prix indiqué dans la liste de prix sur la catégorie « tissu Client ».

Les tissus appartenant au client et qui nous sont envoyés pour recouvrir nos propres modèles doivent être livrés en port payé.

Les couleurs des tissus et des cuirs de la collection échantillons sont indicatives.

Pour le lavage des tissus de notre collection, Veuillez suivre les instructions figurant dans le livre d'échantillons. Sur demande, Vibieffe peut se charger du pré-lavage de nos tissus, en appliquant une surcharge. Une colonne spéciale, dans la liste COLLECTION TISSUS (de la page 7 à la page 10) indique où ce traitement est possible.

Sans aucun préavis Vibieffe a le droit d'apporter des modifications techniques aux produits.

RISERVATO DOMINIO

La merce viene venduta con patto di riservato dominio, pertanto il trasferimento della proprietà al compratore avverrà solo al momento dell'integrale pagamento del prezzo e di ogni altro eventuale credito accessorio.

Laddove il pagamento del prezzo sia pattuito mediante assegni, cambiali, effetti, cessioni, etc.. il trasferimento della proprietà avverrà con l'effettivo pagamento, anche nel caso in cui il relativo credito venga inserito in un conto corrente. Qualora prima dell'integrale pagamento del prezzo il compratore trasformi la merce acquistata, la riserva di proprietà deve ritenersi estesa alla cosa risultante dalla trasformazione. Se la trasformazione comporta l'unione e/o la commistione con cose appartenenti a proprietari diversi, la riserva di proprietà si estende alla cosa risultante dalla trasformazione in misura pari al valore della merce venduta, quantificato in ragione del prezzo.

Nel caso in cui, nonostante il presente patto, la merce o la cosa risultante della trasformazione vengano vendute, la scrivente acquisirà il credito del compratore al pagamento del prezzo nei confronti del sub acquirente, nei limiti del prezzo della merce venduta.

RETENTION OF TITLE

The goods is sold with retention of title, so the transfer of property to the buyer, will be only at the time of full payment and of any other possible credit.

Where payment is agreed by checks, bills of exchange, promissory, banker's draft a.s.o... the transfer of ownership will take place only with the real payment, even if the credit will be insert into a Bank account.

If, before the full payment the buyer transforms the purchased product, the retention will be considered as extended to the resulting product from this process.

If the transformation leads the union and/or mixture of things belonging to other owners, the retention of ownership will be extended to what is the result from the process in equal value of the due amount to be paid.

If, despite this agreement, the product or the result of the transformed item, is sold, we will acquire the credit rights towards the sub-buyer for the due amount of due credit.

EIGENTUMSVORBEHALT

AGB Die Ware wird unter Eigentumsvorbehalt verkauft, so dass die verkaufte Ware solange im Eigentum des Verkäufers bleibt, bis der Kaufpreis u. alle zugehörigen Nebenkosten endgültig bezahlt sind. Der Verkäufer ist daneben berechtigt, bei Zahlungsverzug des Käufers die Sache zurückzuverlangen. Erfolgt eine Verarbeitung mit uns nicht gehörenden Gegenständen, so erwerben wir an der neuen Sache das Miteigentum im Verhältnis zum Wert des von uns gelieferten Gegenstandes zu den sonstigen verarbeiteten Gegenständen. Dasselbe gilt, wenn der gelieferte Gegenstand mit anderen, uns nicht gehörenden Gegenständen vermischt wird.

RÉSERVE DE PROPRIÉTÉ

Les produits sont vendus avec réserve de propriété, de sorte que le transfert de propriété à l'acheteur, sera seulement au moment du paiement intégral et de tout autre crédit possible.

Lorsque le paiement est accepté par chèques, lettres de change, ou autre titres, le transfert de propriété ne sera fait que au moment du paiement effectif, même si le crédit sera inséré dans un compte bancaire.

Si, avant le paiement intégral de la part de l'acheteur, il transforme le produit acheté, la réserve de propriété sera considérée comme prolongée pour le produit résultant de ce processus.

Si la transformation conduit à la liaison et/ou un mélange de choses qui appartiennent à d'autres propriétaires, la réserve de propriété sera étendue à ce qui est le résultat du processus pour la valeur du montant à payer.

Si, en dépit de cet accord, le produit ou le résultat de l'élément transformé, est vendu, nous allons acquérir les droits de crédit vers le sous-acquéreur pour la somme du crédits qui nous est dû.

COLLEZIONE TESSUTI / FABRIC COLLECTION / STOFFKOLLEKTION / COLLECTION TISSUS

	COMPOSIZIONE / COMPOSITION	CIGARETTE TEST	CAL 117	MARTINDALE (cicli)	PRELAVAGGIO PREWASH (*)	LAVAGGIO / WASHING
Categoria EXTRA						
Collezione SOTTOBOSCO						
VISIR col. 04	39% PL 27% CO 17% LI 17% PC	NO	OK	20.800	OK	
REGENT CHEVRON col. 05	36% VI 24% CO 24% PL 16% LI	OK	OK	25.000	NO	
REGENT DAMIER col. 05	33% PL 32% VI 21% CO 14% LI	OK	NO	20.000	NO	
MAX col. 03/09	57% VI 21% PL 15% CO 7% LI	OK	OK	26.500	NO	
VISIR col. 11	39% PL 27% CO 17% LI 17% PC	NO	OK	20.800	OK	
BOGART col. 01	73% PL 27% AC	NO	OK	100.000	NO	
SPARTACUS col. 16/13	100% LI	OK	OK	21.000	OK	
TUSCANY col. 03	48% CO 29% PL 23% PC	NO	NO	25.000	OK	
JOKER col. 03	100% PL	OK	OK	45.000	OK	
JACQUARD col. 07	46% PL 36% CO 18% PC	NO	NO	25.000	NO	
Collezione MINERALE						
RAZ col. 03	38% CO 31% PC 14% PL 9% LI 8% VI	NO	NO	30.000	NO	
SPARTACUS col. 10/07	100% LI	OK	OK	21.000	OK	
RAZ col. 09	38% CO 31% PC 14% PL 9% LI 8% VI	NO	NO	30.000	NO	
VISIR col. 13/06	39% PL 27% CO 17% LI 17% PC	NO	OK	20.800	OK	
CLEO col. 06	80% PC 20% LI	NO	NO	20.000	OK	
REGENT CHEVRON col. 04	36% VI 24% CO 24% PL 16% LI	OK	OK	25.000	NO	
REGENT DAMIER col. 04	33% PL 32% VI 21% CO 14% LI	OK	NO	20.000	NO	
JACQUARD col. 12	46% PL 36% CO 18% PC	NO	NO	25.000	NO	
MAX col. 13	57% VI 21% PL 15% CO 7% LI	OK	OK	26.500	NO	
BOGART col. 06	73% PL 27% AC	NO	OK	100.000	NO	
Collezione SAVANA_1						
AZIMUT col. 904/303	92% PES 5% CO 3% LA	OK	OK	100.000	OK	
FRED col. 314	50% VI 24% PL 15% CO 10% LI 1% PA	NO	NO	30.000	NO	
JACK col. 38	38% CO 37% VI 12% PL 9% LI 2% AF 2% PA	NO	NO	25.000	NO	
JAMES col. 04	50% PL 39% PC 11% VI	OK	OK	27.000	NO	
MEDITERRANEO col. 3	39% CO 32% VI 16% LI 13% PL	OK	OK	40.000	OK	
PANTHEON col. 7	29% VI 24% CO 23% PC 14% LI 7% PL 3% PA 1% WO	OK	OK	20.000	NO	
Collezione GLACIER_2						
FRED col. 3	50% VI 24% PL 15% CO 10% LI 1% PA	NO	NO	30.000	NO	
TOM col. 82	38% CO 37% VI 12% PL 9% LI 2% AF 2% PA	NO	NO	25.000	NO	
PANTHEON col. 1/3	29% VI 24% CO 23% PC 14% LI 7% PL 3% PA 1% WO	OK	OK	20.000	NO	
MEDITERRANEO col. 1/17/18	39% CO 32% VI 16% LI 13% PL	OK	OK	40.000	OK	
Collezione DUNE_3						
JERRY col. 42	80% CO 11% VI 7% PL 2% AF	NO	NO	20.000	NO	
PANTHEON col. 4	29% VI 24% CO 23% PC 14% LI 7% PL 3% PA 1% WO	OK	OK	20.000	NO	
AZIMUT col. 400/901	92% PES 5% CO 3% LA	OK	OK	100.000	OK	
MEDITERRANEO col. 12	39% CO 32% VI 16% LI 13% PL	OK	OK	40.000	OK	
JAMES col. 06	50% PL 39% PC 11% VI	OK	OK	27.000	NO	
FRED col. 17	50% VI 24% PL 15% CO 10% LI 1% PA	NO	NO	30.000	NO	

(*) Possibilità prelavaggio a pagamento / Pre-wash available with surcharge

COLLEZIONE TESSUTI / FABRIC COLLECTION / STOFFKOLLEKTION / COLLECTION TISSUS

	COMPOSIZIONE / COMPOSITION	CIGARETTE TEST	CAL 117	MARTINDALE (cicli)	PRELAVAGGIO PREWASH (*)	LAVAGGIO / WASHING
Categoria SUPER						
CLOU	52% LI 48% VI	OK	NO	22.000	NO	
ROBERTA	60% VI 18% CO 12% LI 10% PL	NO	OK	25.000	NO	
FRANCIS	30% VI 20% PL 20% AC 15% CO 15% LI	OK	NO	24.000	NO	
Collezione MARTE						
FLYNN col. 09	70% PC 18% PL 10% CO 2% AF	OK	OK	40.000	NO	
SAVOIA col. 01	80% PL 20% CO	OK	OK	100.000	OK	
PONGO col. 22	80% PL 20% CO	NO	OK	100.000	OK	
BARBADOS col. 06/03	45% PL 33% CO 14% VI 8%LI	OK	NO	25.000	OK	
LEVANTE col. 05/08	47% PC 19% WO 16% PL 15% CO 3% NY	OK	OK	30.000	NO	
GHIBLI col. 05	49% PC 22% WO 15% PL 11% CO 3% NY	NO	NO	30.000	NO	
Collezione GIOVE						
LEVANTE Col. 04	47% PC 19% WO 16% PL 15% CO 3%NY	OK	OK	30.000	NO	
FLYNN col. 11	70% PC 18% PL 10% CO 2% AF	OK	OK	40.000	NO	
PONGO col. 10/15	80% PL 20% CO	NO	OK	100.000	OK	
MONREALE col. 100	82% VI 18% PL	NO	NO	20.000	NO	
BRERA col. 01	59% PC 26% CO 10% WO 5% PL	OK	OK	30.000	NO	
JAZZ col. 08	51% PL 30% CO 19% PC	NO	OK	25.000	OK	
BARBADOS col. 21	45% PL 33% CO 14% VI 8%LI	OK	NO	25.000	OK	
Collezione NETTUNO						
FLYNN col. 12	70% PC 18% PL 10% CO 2% AF	OK	OK	40.000	NO	
SAVOIA col. 117/111	80% PL 20% CO	OK	OK	100.000	OK	
PONGO col. 30	80% PL 20% CO	NO	OK	100.000	OK	
LEVANTE col. 07/06	47% PC 19% WO 16% PL 15% CO 3%NY	OK	OK	30.000	NO	
GHIBLI col. 04	49% PC 22% WO 15% PL 11% CO 3% NY	NO	NO	30.000	NO	
BARBADOS col. 22	45% PL 33% CO 14% VI 8%LI	OK	NO	25.000	OK	
Collezione VENERE						
ORSETTO col. 01/1	34% VI 33% PC 17% WO 8% PL 4% LI 4% CO	OK	OK	50.000	NO	
FLYNN col. 04/01	70% PC 18% PL 10% CO 2% AF	OK	OK	40.000	NO	
PONGO col. 23	80% PL 20% CO	NO	OK	100.000	OK	
MONREALE col. 01	82% VI 18% PL	NO	NO	20.000	NO	
BRERA col. 02	59% PC 26% CO 10% WO 5% PL	OK	OK	30.000	NO	
BARBADOS col. 04	45% PL 33% CO 14% VI 8%LI	OK	NO	25.000	OK	
GHIBLI col. 07	49% PC 22% WO 15% PL 11% CO 3% NY	NO	NO	30.000	NO	
SAVOIA col. 08	80% PL 20% CO	OK	OK	100.000	OK	

(*) Possibilità prelavaggio a pagamento / Pre-wash available with surcharge

COLLEZIONE TESSUTI / FABRIC COLLECTION / STOFFKOLLEKTION / COLLECTION TISSUS

	COMPOSIZIONE / COMPOSITION	CIGARETTE TEST	CAL 117	MARTINDALE (cicl)	PRELAVAGGIO PREWASH (*)	LAVAGGIO / WASHING
Categoria NATURE						
Collezione CARBONE						
SIERRA DIS. col.302	69% PC 20% PL 11% CO	OK	OK	20.000	NO	
MUMBLE col. 02	72% RPET 28% PL	OK	OK	50.000	NO	
HOMBRE col. 01	52% PL 42% PC 6% CO	OK	OK	22.000	NO	
VELD col. 9	45% VI 32% CO 16% PL 7% LI	OK	NO	25.000	NO	
SIERRA DIS. col.102	69% PC 20% PL 11% CO	OK	OK	20.000	NO	
GREENIOUS col. 900	70% ECO CO GRS 24% CO 2%PL 2%PC 2%WO	NO	OK	18.000	OK	
BOMBACIO col. 900	80% ECO CO GRS 6% WO 6%VI 5% PA 3% SE	NO	OK	100.000	OK	
RATIO col. 900	45% ECO CO GRS 36% PL 19% AC	NO	OK	20.000	NO	
Collezione CORTECCIA						
RATIO col. 200	45% ECO CO GRS 36%PL 19% AC	NO	OK	20.000	NO	
GREENIOUS col. 200	70% ECO CO GRS 24% CO 2% PL 2% PC 2% WO	NO	OK	18.000	OK	
AQUATONIC col. 201	48% AC 41% PL 11% CO	OK	OK	80.000	NO	
SANTOS col.17	52% PL 48% PC	OK	OK	25.000	NO	
BOMBACIO col. 201	80% ECO CO GRS 6% WO 6%VI 5% PA 3% SE	NO	OK	100.000	OK	
MUMBLE col. 14	72% RPET 28% PL	OK	OK	50.000	NO	
SIERRA DIS. Col. 113	69% PC 20% PL 11% CO	OK	OK	20.000	NO	
SPLIT col. 016	70% PL riciclato 30% PL	OK	OK	60.000	NO	
Collezione AVENA						
SIERRA DIS. col. 114	69% PC 20% PL 11% CO	OK	OK	20.000	NO	
SIERRA DIS. col. 312	69% PC 20% PL 11% CO	OK	OK	20.000	NO	
DELIRIUM col. 21	35% PC 24% PL 19% VI 14% CO 3% AF	OK	OK	45.000	NO	
SPLIT col. 005	70% PL riciclato 30% PL	OK	OK	60.000	NO	
HOMBRE col. 04	52% PL 42% PC 6% CO	OK	OK	22.000	NO	
BLOSSOM col. 207	100% PL (recycled and biodegradable) STAIN REPELLENT	OK	OK	40.000	NO	
SANTOS col. 29	52% PL 48% PC	OK	OK	25.000	NO	
DELIRIUM col. 01	35% PC 24% PL 19% VI 14% CO 3% AF	OK	OK	45.000	NO	

(*) Possibilità prelavaggio a pagamento / Pre-wash available with surcharge

**PREZZI DEI TESSUTI AL ML. / PRICE OF FABRICS PER LINEAR METER /
 PREISE DER STOFFE PRO LAUFMETER / PRIX DES TISSUS PAR MÈTRE LINÉAIRE**

Categoria tessuto / Fabric category			D/F/Aqua	Extra	Super	Nature	
Euro			137	188	219	236	





Descrizione prodotto
Divani

Caratteristiche tecniche

- Struttura:** telaio multistrato di pino con struttura portante in metallo, cinghie elastiche su schienali
- Molleggio:** nastri elastici unidirezionali ad alta portata
- Imbottitura:** poliuretano espanso ricoperto con resinato accoppiato vellutino
- Meccanismo:** meccanismo di traslazione schienale in metallo
- Piedi:** rovere tinto moka o noce Canaletto.
- Rivestimento:** rivestimento in tessuto o in pelle. Rivestimento in tessuto completamente sfoderabile
- Finitura rivestimento:** trapuntatura con cordolo nero
- Opzione:** fasce in colore diverso

Description of the product
Sofas

Technical features

- Frame:** solid poplar wood and iron supports for back and frame. Elastic bands for back.
- Springing:** high resistance unidirectional elastic bands
- Padding:** polyurethane foam covered with heated bonded polyester fibre
- Mechanism:** backrest sliding mechanism in metal
- Feet:** moka dyed oak or Canaletto walnut wood.
- Cover:** fabric or leather cover. Fabric cover removable
- Cover finishing:** quilted with black fabric piping
- Option:** cover in different colour on sides

Produktbeschreibung
Sofas

Technische Angaben

- Gestell:** Pappelschichtholz m. Traggestell aus Metall. Ruchenlehne m. elastischen Gurten
- Federung:** mit hochbelastbaren und unidirektionalem elastischen Gurten
- Polsterung:** Polyurethanschaumstoff mit samtartiger Resinat Abdeckung
- Mécanisme:** Verschiebungsmechanismus der Rückenlehne aus Metall.
- FüÙe:** mokkagebeizte Eiche o. Canaletto Walnuss.
- Bezug:** Bezug aus Stoff oder Leder. Stoffbezug ganz abnehmbar
- Finishing des Bezugs:** mit schwarzem Keder gesteppt
- Option:** Bezug mit Einsatz in verschiedener Farbe

Description du produit
Canapés

Caractéristiques techniques

- Structure:** aggloméré de peuplier avec structure en fer, sangles élastiques sur dossier
- Suspension:** sangles élastiques unidirectionnelles à haute résistance
- Rembourrage:** mousse de polyuréthane de différents densités, enrobée en fibre thermomoullée
- Mécanismus:** mécanisme de translation du dossier en métal
- Pieds:** chêne teinté moka ou noyer Canaletto.
- Revêtement:** revêtement en tissu ou en cuir. Revêtement en tissu entièrement déhoussable
- Finition revêtement :** matelassé avec passepoil noir
- Option:** Possibilité de recouvrir la bande d'une couleur différente

- B - Espanso densità portante / Foam supporting density
- C - Resinato / Heated bonded polyester fibre
- D - Espanso densità soft / Foam soft density
- E - Fusto in legno / Wooden frame
- F - Telaio in ferro / Iron frame

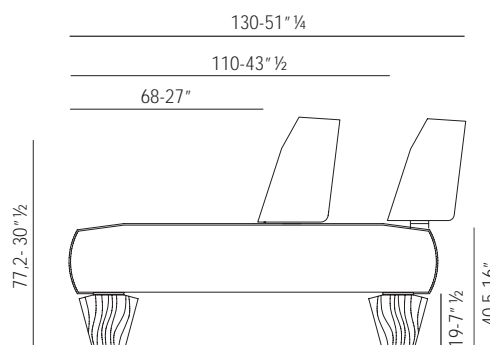
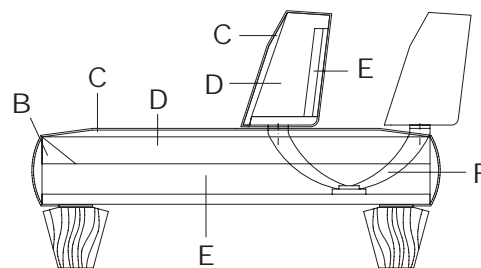

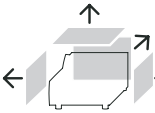
M ³	Kg.	MI.	M ²		 <p>Possibile su misura Special sizes available</p>	Tessuto - Fabric				Pelle - Leather			
Volume Volume	Peso Weight	Tessuto Fabric	Pelle Leather	Imballi legno Wood packaging		<input type="checkbox"/> previsto (rif. tab. pag. 3) / available: s.table p.3 <input type="checkbox"/> incluso / included	Tessuto cliente COM	D - F - Aqua	Extra	Super	Nature	Pelle cliente COL	Pelle

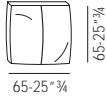

Cuscinetto bicolor / Two-tone cushion 99

25001

0,05	3	0,7	1,4	'	+10%																	
						Rivestimento / Replacement cover	198	201	221	236	255	297	349	423	119	122	133	143	153	180	211	255

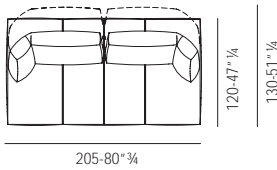

Opzione bicolor / Two-tone option 505

25002

1,4	70	8,9	14,4	'	+10%																	
						Rivestimento / Replacement cover	4.366	4.497	4.670	4.823	5.094	5.859	7.212	8.918	2.620	2.699	2.803	2.894	3.057			

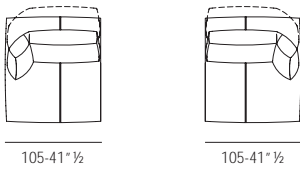

Opzione bicolor / Two-tone option 505

25003

25004

0,8	31,5	5,9	7,8	'	+10%																	
						Rivestimento / Replacement cover	1.964	2.026	2.112	2.183	2.308	2.721	3.201	3.943	1.179	1.217	1.268	1.310	1.385			



Opzione bicolor / Two-tone option 505

25005

0,7	30	5,9	7,8	'	+10%																	
						Rivestimento / Replacement cover	1.883	1.942	2.024	2.093	2.212	2.607	3.067	3.779	1.130	1.166	1.216	1.257	1.328			

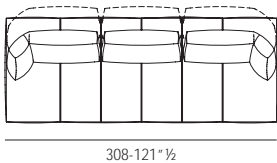

Opzione bicolor / Two-tone option 505

25006

2,4	97,7	11,9	20,1	'	+10%																	
						Rivestimento / Replacement cover	4.910	5.065	5.279	5.459	5.771	6.636	8.000	9.856	2.947	3.039	3.168	3.275	3.463			

I prezzi sono espressi in Euro
Prices are in Euro

Consultare condizione di vendita e avvertenze importanti
Please check our sale conditions and important remarks

M ³	Kg.	MI.	M ²			Tessuto - Fabric					Pelle - Leather			
Volume Volume	Peso Weight	Tessuto Fabric	Pelle Leather	Imballi legno Wood packaging	Prelavaggio p. 7/10 Prewash p. 7/10		Tessuto cliente COM	D - F - Aqua	Extra	Super	Nature	Pelle cliente COL	Pelle	Pelle Lusso
					<input type="radio"/> previsto (rif. tab. pag. 3) / available: s.table p.3 <input type="radio"/> incluso / included									

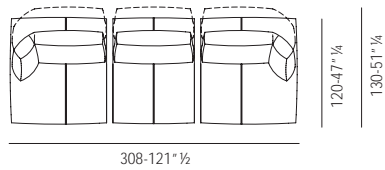

Opzione bicolore / Two-tone option 505

25007 Disassembled						5.983	6.167	6.419	6.633	7.002	8.221	9.640	11.837					
2,4	97,7	11,9	20,1	'	+10%	Rivestimento / Replacement cover					3.590	3.701	3.852	3.981	4.202			

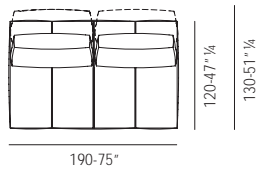

Opzione bicolore / Two-tone option 505

25008						3.136	3.237	3.374	3.490	3.690	4.243	5.151	6.363					
1,2	60	7,6	13,1	'	+10%	Rivestimento / Replacement cover					1.882	1.942	2.024	2.095	2.215			

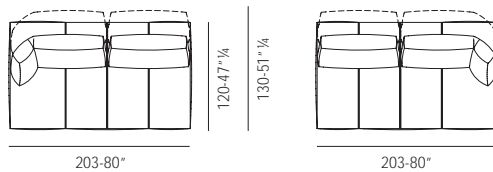

Opzione bicolore / Two-tone option 505

25009						25010						3.434	3.551	3.718	3.854	4.078	4.690	5.539	6.809	
1,3	65	8,9	13,3	'	+10%	Rivestimento / Replacement cover					2.061	2.130	2.231	2.313	2.447					

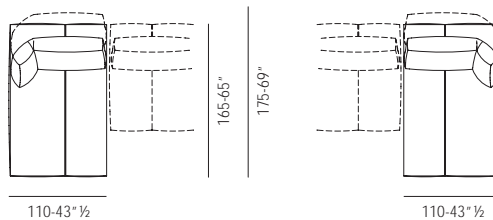

Opzione bicolore / Two-tone option 505

25011						25012						3.285	3.394	3.546	3.672	3.884	4.467	5.345	6.586	
1,0	60	7,6	9,9	'	+10%	Rivestimento / Replacement cover					1.972	2.037	2.128	2.203	2.330					

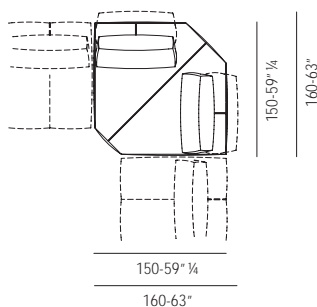

Opzione bicolore / Two-tone option 505

25013						4.078	4.207	4.386	4.537	4.797	5.516	6.696	8.273						
1,1	70	7,4	10,2	'	+10%	Rivestimento / Replacement cover					2.447	2.524	2.632	2.723	2.879				

I prezzi sono espressi in Euro
Prices are in Euro

Consultare condizione di vendita e avvertenze importanti
Please check our sale conditions and important remarks

M ³	Kg.	MI.	M ²			Tessuto - Fabric					Pelle - Leather			
Volume Volume	Peso Weight	Tessuto Fabric	Pelle Leather	Imballi legno Wood packaging	Prelavaggio p. 7/10 Prewash p. 7/10		Tessuto cliente COM	D - F - Aqua	Extra	Super	Nature	Pelle cliente COL	Pelle	Pelle Lusso
					<input type="radio"/> previsto (rif. tab. pag. 3) / available: s.table p.3 <input type="radio"/> incluso / included									

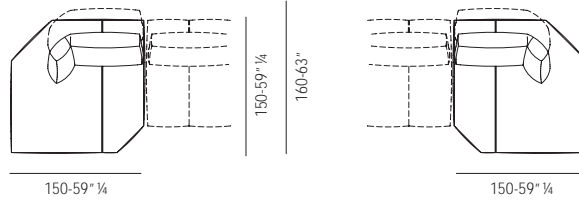

Opzione bicolor / Two-tone option 505

25015	25014	3.765	3.884	4.049	4.187	4.428	5.092	6.181	7.636
		2.259	2.330	2.429	2.513	2.657			

1,1	75	6,3	9,2	'	+10%
-----	----	-----	-----	---	------

Rivestimento / Replacement cover

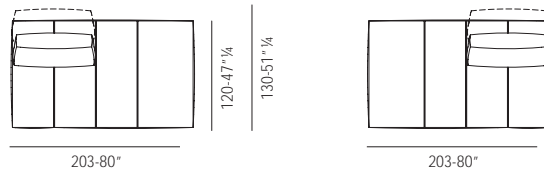

Opzione bicolor / Two-tone option 505

25017	25016	2.838	2.921	3.030	3.126	3.301	3.797	4.763	5.919
		1.703	1.754	1.818	1.876	1.981			

1,2	55	7,1	11,0	'	+10%
-----	----	-----	------	---	------

Rivestimento / Replacement cover

M ³	Kg.				
Volume Volume	Peso Weight	Imballi legno Wood packaging			Rovere tinto Moka o noce Moka dyed oak or Canaletto walnut wood

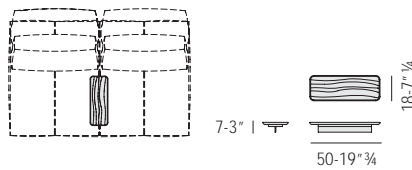

25018

0,2	10,0	'	555
-----	------	---	-----

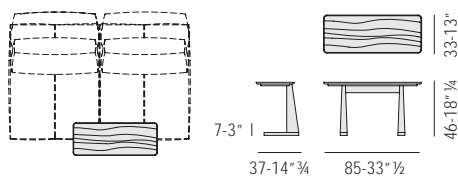

25019

0,05	5,0	'	1.142
------	-----	---	-------

I prezzi sono espressi in Euro
Prices are in Euro

Consultare condizione di vendita e avvertenze importanti
Please check our sale conditions and important remarks

<p><i>Il totale delle composizioni potrà non corrispondere a causa di arrotondamenti automatici.</i></p> <p><i>The total amount in compositions may not correspond to the sum of single prices due to automatic rounding.</i></p>	Q.ta / Qty / Q.té / Stk	Tessuto - Fabric					Pelle - Leather		
		Tessuto cliente COM	D - F - Aqua	Extra	Super	Nature	Pelle cliente COL	Pelle	Pelle Lusso

	25009	1	3.434	3.551	3.718	3.854	4.078	4.690	5.539	6.809
	25014	1	3.765	3.884	4.049	4.187	4.428	5.092	6.181	7.636
1	Totale / Total		7.198	7.434	7.767	8.040	8.563	9.781	11.719	14.445

	25009	1	3.434	3.551	3.718	3.854	4.078	4.690	5.539	6.809
	25012	1	3.285	3.394	3.546	3.672	3.884	4.467	5.345	6.586
2	Totale / Total		6.719	6.944	7.264	7.525	7.961	9.156	10.883	13.395

	25016	1	2.838	2.921	3.030	3.126	3.301	3.797	4.763	5.919
	25012	1	3.285	3.394	3.546	3.672	3.884	4.467	5.345	6.586
3	Totale / Total		6.123	6.315	6.576	6.798	7.185	8.263	10.107	12.505

	25009	1	3.434	3.551	3.718	3.854	4.078	4.690	5.539	6.809
	25013	1	4.078	4.207	4.386	4.537	4.797	5.516	6.696	8.273
	25008	1	3.136	3.237	3.374	3.490	3.690	4.243	5.151	6.363
	25010	1	3.434	3.551	3.718	3.854	4.078	4.690	5.539	6.809
4	Totale / Total		14.081	14.544	15.196	15.733	16.641	19.137	22.923	28.253

I prezzi sono espressi in Euro
Prices are in Euro

Consultare condizione di vendita e avvertenze importanti
Please check our sale conditions and important remarks

**Descrizione prodotto**

Divani

Caratteristiche tecniche**Struttura:** telaio multistrato di pioppo con struttura portante in metallo, cinghie elastiche su schienali**Molleggio:** nastri elastici unidirezionali ad alta portata**Imbottitura:** poliuretano espanso ricoperto con resinato accoppiato vellutino**Piedi: tecnici neri.****Rivestimento:** rivestimento in tessuto o in pelle. Rivestimento in tessuto completamente sfoderabile**Opzione:** no fodera trapunta**Description of the product**

Sofas

Technical features**Frame:** solid poplar wood and iron supports for back and frame. Elastic bands for back.**Springing:** high resistance unidirectional elastic bands**Padding:** polyurethane foam covered with heated bonded polyester fibre**Feet:** black standard.**Cover:** fabric or leather cover. Fabric cover removable**Option:** Non-quilted cover**Produktbeschreibung**

Sofas

Technische Angaben**Gestell:** Pappelschichtholz m. Traggestell aus Metall. Ruchenlehne m. elastischen Gurten**Federung:** mit hochbelastbaren und unidirektionalem elastischen Gurten**Polsterung:** Polyurethanschaumstoff mit samtartiger Resinat Abdeckung**FüÙe:** Standard schwarz.**Bezug:** Bezug aus Stoff oder Leder.

Stoffbezug ganz abnehmbar

Option: Bezug nicht gesteppt**Description du produit**

Canapés

Caractéristiques techniques**Structure:** aggloméré de peuplier avec structure en fer, sangles élastiques sur dossier**Suspension:** sangles élastiques unidirectionnelles à haute résistance**Rembourrage:** mousse de polyuréthane de différents densités, enrobée en fibre thermomoullée**Pieds:** standard noir.**Revêtement:** revêtement en tissu ou en cuir.

Revêtement en tissu entièrement déhoussable

Option: revêtement pas matelassé

B - Espanso densità portante / Foam supporting density

C - Resinato / Heated bonded polyester fibre

D - Espanso densità soft / Foam soft density

E - Fusto in legno / Wooden frame

F - Cinghie elastiche / Elastic belt

G - Fusto in ferro / Metal structure

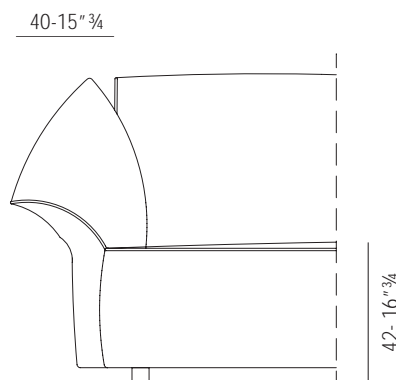
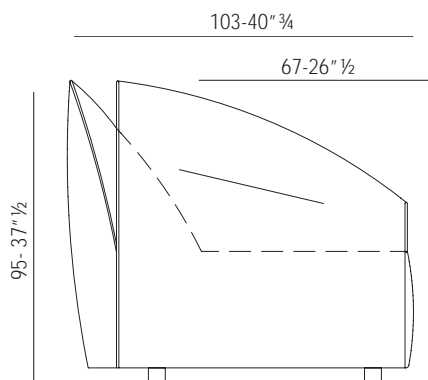
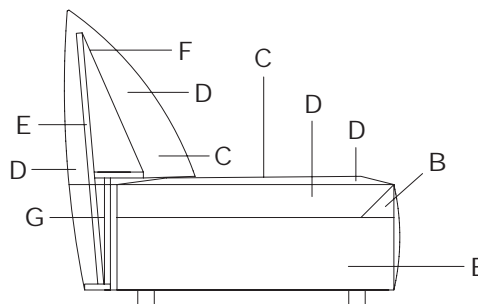

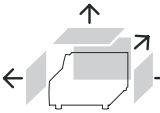
M ³	Kg.	MI.	M ²			Tessuto - Fabric					Pelle - Leather			
Volume Volume	Peso Weight	Tessuto Fabric	Pelle Leather	Imballi legno Wood packaging	Prelavaggio p. 7/10 Prewash p. 7/10	 Possibile su misura Special sizes available	Tessuto cliente COM	D - F - Aqua	Extra	Super	Nature	Pelle cliente COL	Pelle	Pelle Lusso
							<input type="radio"/> previsto (rif. tab. pag. 3) / available: s.table p.3 <input type="radio"/> incluso / included							

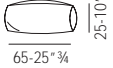
						35001	267	280	312	327	335	342	404	478
0,1	2,0	1,0	0,6	'	+10%	NO Trapunta / Non-quilted cover	255	266	297	311	319	326	384	454
						Rivestimento / Replacement cover	175	183	204	213	219			

						35002	480	504	561	590	603	617	726	859
0,1	4,0	1,0	1,6	'	+10%	NO Trapunta / Non-quilted cover	457	480	533	561	573	587	690	816
						Rivestimento / Replacement cover	312	329	365	384	393			

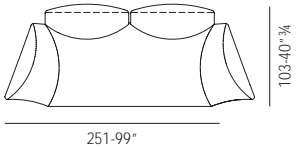
						35003	4.827	5.003	5.423	5.633	5.739	6.386	7.514	9.083
2,2	70	18,9	25,2	'	+10%	NO Trapunta / Non-quilted cover	4.587	4.753	5.153	5.353	5.452	6.068	7.138	8.630
						Rivestimento / Replacement cover	3.139	3.253	3.526	3.663	3.731			

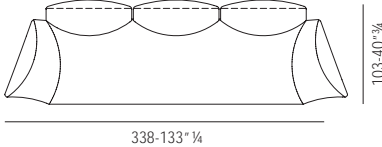
						35004	6.309	6.540	7.095	7.372	7.510	8.440	9.929	12.058
3,1	82	20,6	27,3	'	+10%	NO Trapunta / Non-quilted cover	5.994	6.213	6.740	7.003	7.135	8.019	9.433	11.456
						Rivestimento / Replacement cover	4.102	4.252	4.612	4.793	4.883			

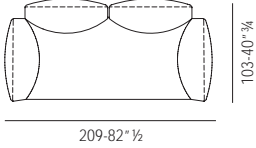
						35005	4.518	4.682	5.077	5.633	5.273	6.008	7.135	8.561
2,2	70	18,9	25,2	'	+10%	NO Trapunta / Non-quilted cover	4.292	4.448	4.824	5.353	5.010	5.707	6.779	8.134
						Rivestimento / Replacement cover	2.938	3.044	3.300	3.663	3.429			

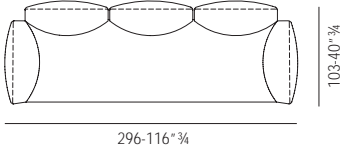
						35006	6.000	6.219	6.748	7.011	7.145	8.061	9.550	11.535
3,1	82	20,6	27,3	'	+10%	NO Trapunta / Non-quilted cover	5.700	5.908	6.411	6.661	6.788	7.659	9.073	10.959
						Rivestimento / Replacement cover	3.901	4.043	4.387	4.558	4.645			

I prezzi sono espressi in Euro
Prices are in Euro

Consultare condizione di vendita e avvertenze importanti
Please check our sale conditions and important remarks

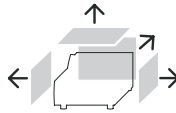
M ³	Kg.	MI.	M ²			Tessuto - Fabric					Pelle - Leather			
Volume Volume	Peso Weight	Tessuto Fabric	Pelle Leather	Imballi legno Wood packaging	Prelavaggio p. 7/10 Prewash p. 7/10	 Possibile su misura Special sizes available	Tessuto cliente COM	D - F - Aqua	Extra	Super	Nature	Pelle cliente COL	Pelle	Pelle Lusso
							<input type="checkbox"/> previsto (rif. tab. pag. 3) / available: s.table p.3 incluso / included							

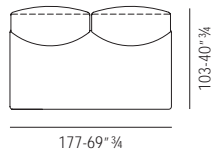

35007

1,7	46	11,1	14,4	'	+10%			2.963	3.074	3.343	3.477	3.545	4.107	4.831	5.949
						NO Trapunta / Non-quilted cover		2.815	2.920	3.177	3.304	3.368	3.902	4.589	5.652
						Rivestimento / Replacement cover		1.927	1.999	2.174	2.261	2.305			

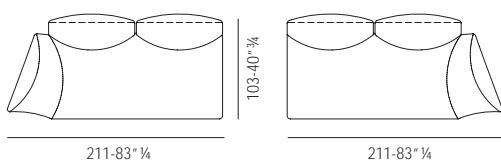

35009

35008

2,0	54	13,7	18,0	'	+10%			3.895	4.038	4.383	4.556	4.641	5.247	6.173	7.516
						NO Trapunta / Non-quilted cover		3.701	3.837	4.164	4.328	4.410	4.984	5.864	7.141
						Rivestimento / Replacement cover		2.532	2.626	2.850	2.962	3.017			

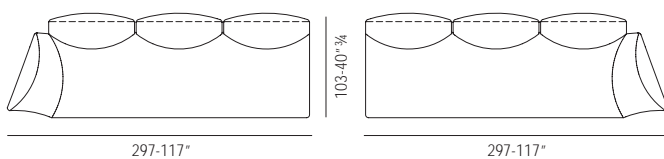

35011

35010

2,8	74	18,0	23,7	'	+10%			5.376	5.576	6.055	6.294	6.413	7.300	8.588	10.490
						NO Trapunta / Non-quilted cover		5.108	5.297	5.752	5.980	6.093	6.935	8.159	9.966
						Rivestimento / Replacement cover		3.496	3.625	3.937	4.092	4.169			

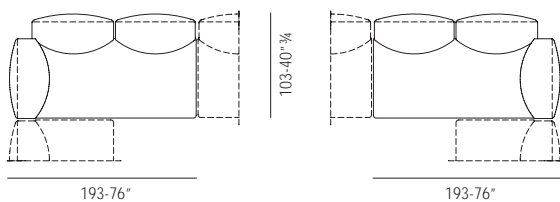

35013

35012

1,9	54	13,7	18,0	'	+10%			3.739	3.878	4.209	4.376	4.459	5.057	5.949	7.255
						NO Trapunta / Non-quilted cover		3.553	3.685	3.999	4.157	4.236	4.805	5.652	6.892
						Rivestimento / Replacement cover		2.432	2.522	2.737	2.845	2.898			

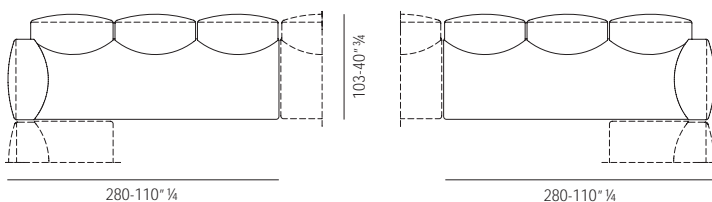

35015

35014

2,7	74	18,0	23,7	'	+10%			5.221	5.415	5.881	6.114	6.231	7.110	8.364	10.228
						NO Trapunta / Non-quilted cover		4.960	5.145	5.587	5.809	5.920	6.755	7.946	9.718
						Rivestimento / Replacement cover		3.394	3.521	3.824	3.975	4.051			

I prezzi sono espressi in Euro
Prices are in Euro

Consultare condizione di vendita e avvertenze importanti
Please check our sale conditions and important remarks

M ³	Kg.	MI.	M ²			Tessuto - Fabric					Pelle - Leather			
Volume	Peso	Tessuto	Pelle	Imballi legno	Prelavaggio p. 7/10		Tessuto cliente	D - F - Aqua	Extra	Super	Nature	Pelle cliente	Pelle	Pelle Lusso
Volume	Weight	Fabric	Leather	Wood packaging	Prewash p. 7/10		COM					COL		
						<input type="checkbox"/> previsto (rif. tab. pag. 3) / available: s.table p.3 <input type="checkbox"/> incluso / included								

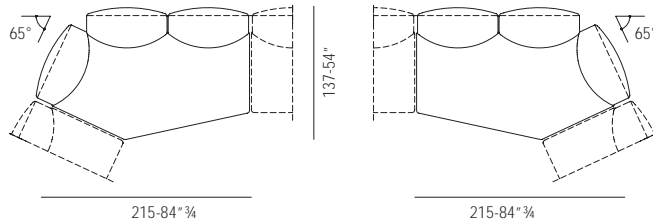

35017

35016

2,5	59	14,8	23,0	'	+10%
-----	----	------	------	---	------

	4.162	4.318	4.692	4.880	4.974	5.719	6.727	8.255
NO Trapunta / Non-quilted cover	3.954	4.103	4.458	4.637	4.726	5.434	6.391	7.843
Rivestimento / Replacement cover	2.706	2.807	3.051	3.173	3.233			

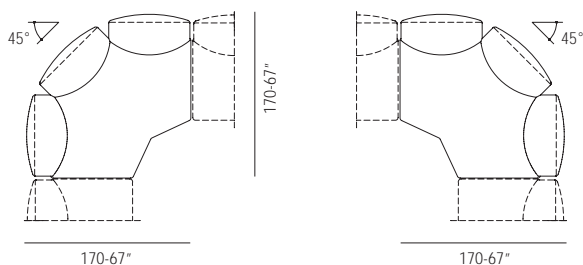

35019

35018

2,5	66	16,2	25,4	'	+10%
-----	----	------	------	---	------

	4.444	4.611	5.014	5.216	5.317	6.159	7.246	8.922
NO Trapunta / Non-quilted cover	4.222	4.381	4.764	4.957	5.051	5.852	6.884	8.476
Rivestimento / Replacement cover	2.889	2.998	3.260	3.392	3.456			

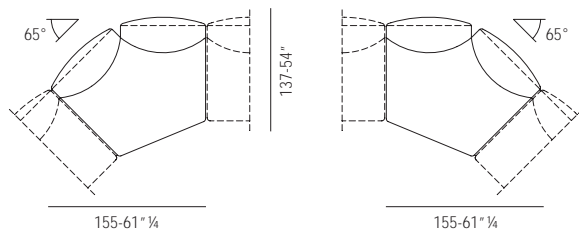

35021

35020

1,9	40	9,9	13,0	'	+10%
-----	----	-----	------	---	------

	2.893	3.001	3.262	3.394	3.459	3.996	4.701	5.781
NO Trapunta / Non-quilted cover	2.748	2.852	3.099	3.225	3.286	3.797	4.467	5.493
Rivestimento / Replacement cover	1.881	1.951	2.121	2.207	2.249			

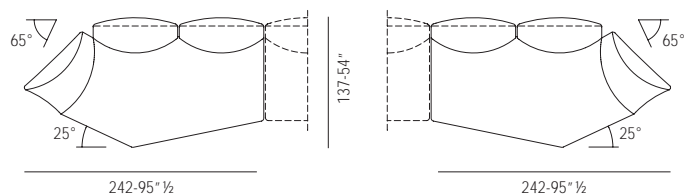

35023

35022

2,7	59	14,8	23,0	'	+10%
-----	----	------	------	---	------

	4.318	4.478	4.865	5.059	5.156	5.908	6.951	8.516
NO Trapunta / Non-quilted cover	4.103	4.256	4.623	4.806	4.899	5.614	6.605	8.091
Rivestimento / Replacement cover	2.807	2.912	3.163	3.289	3.352			

I prezzi sono espressi in Euro
Prices are in Euro

Consultare condizione di vendita e avvertenze importanti
Please check our sale conditions and important remarks

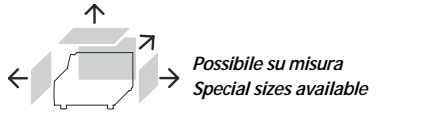
M ³	Kg.	MI.	M ²			Tessuto - Fabric					Pelle - Leather			
Volume	Peso	Tessuto	Pelle	Imballi legno	Prelavaggio p. 7/10		Tessuto cliente	D - F - Aqua	Extra	Super	Nature	Pelle cliente	Pelle	Pelle Lusso
Volume	Weight	Fabric	Leather	Wood packaging	Prewash p. 7/10		COM					COL		
						<input type="checkbox"/> previsto (rif. tab. pag. 3) / available: s.table p.3 <input type="checkbox"/> incluso / included								

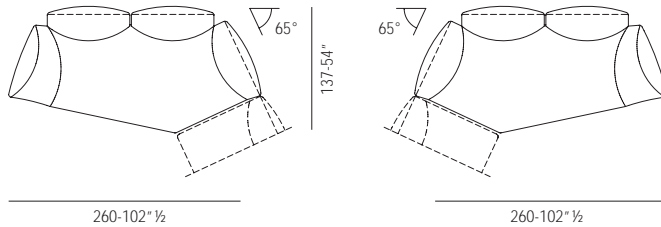

35025

35024

2,9	67	17,4	26,6	'	+10%		5.094	5.282	5.733	5.958	6.070	6.859	8.069	9.823
						NO Trapunta / Non-quilted cover	4.840	5.019	5.446	5.661	5.767	6.517	7.666	9.332
						Rivestimento / Replacement cover	3.312	3.434	3.727	3.873	3.946			

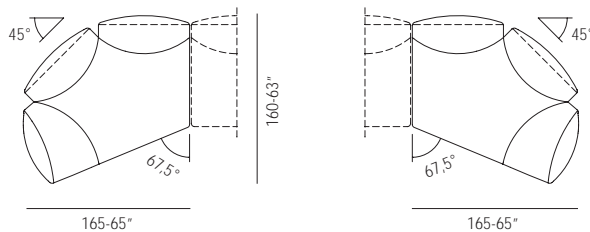

35027

35026

2,3	48	12,5	16,5	'	+10%		3.825	3.966	4.303	4.472	4.556	5.137	6.042	7.349
						NO Trapunta / Non-quilted cover	3.634	3.768	4.088	4.249	4.328	4.880	5.741	6.981
						Rivestimento / Replacement cover	2.487	2.578	2.798	2.908	2.962			

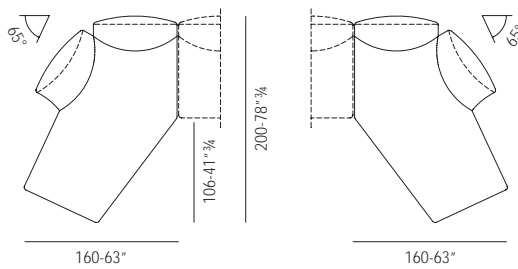

35029

35028

2,9	51	12,2	19,4	'	+10%		3.541	3.676	3.999	4.161	4.243	4.958	5.833	7.210
						NO Trapunta / Non-quilted cover	3.364	3.492	3.799	3.953	4.031	4.711	5.542	6.850
						Rivestimento / Replacement cover	2.302	2.390	2.600	2.706	2.759			

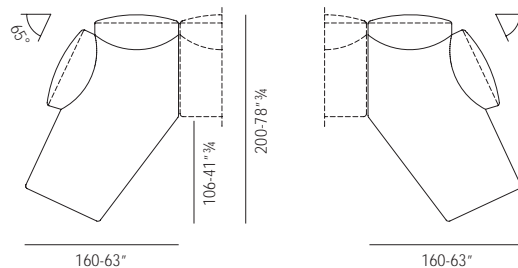

35031

35030

2,9	51	12,2	19,4	'	+10%		3.385	3.514	3.826	3.982	4.059	4.768	5.609	6.949
						NO Trapunta / Non-quilted cover	3.216	3.338	3.635	3.783	3.857	4.530	5.330	6.602
						Rivestimento / Replacement cover	2.201	2.285	2.487	2.589	2.640			

I prezzi sono espressi in Euro
Prices are in Euro

Consultare condizione di vendita e avvertenze importanti
Please check our sale conditions and important remarks

Il totale delle composizioni potrà non corrispondere a causa di arrotondamenti automatici.

The total amount in compositions may not correspond to the sum of single prices due to automatic rounding.

Q.tà / Qty / Q.té / Stk	Tessuto - Fabric					Pelle - Leather		
	Tessuto cliente COM	D - F - Aqua	Extra	Super	Nature	Pelle cliente COL	Pelle	Pelle Lusso

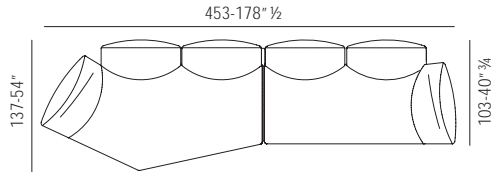

1									
35021	1	4.318	4.478	4.865	5.059	5.156	5.908	7.021	8.516
35008	1	3.895	4.038	4.383	4.556	4.641	5.247	6.173	7.516
Totale / Total		8.213	8.516	9.247	9.615	9.797	11.154	13.193	16.032

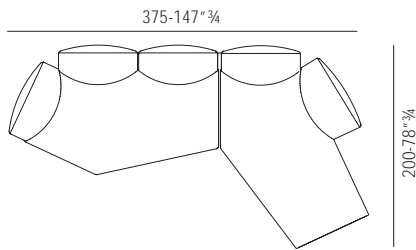

2									
35017	1	4.162	4.318	4.692	4.880	4.974	5.719	6.727	8.255
35030	1	3.385	3.514	3.826	3.982	4.059	4.768	5.609	6.949
Totale / Total		7.546	7.831	8.517	8.862	9.033	10.487	12.336	15.204

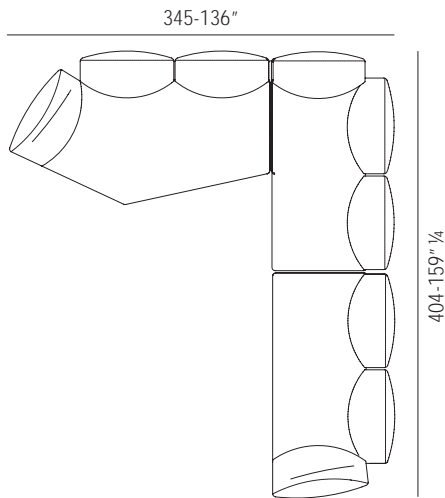

3									
35023	1	4.318	4.478	4.865	5.059	5.156	5.908	7.021	8.516
35013	1	3.739	3.878	4.209	4.376	4.459	5.057	5.949	7.255
35008	1	3.895	4.038	4.383	4.556	4.641	5.247	6.173	7.516
Totale / Total		11.951	12.394	13.456	13.990	14.256	16.211	19.141	23.286

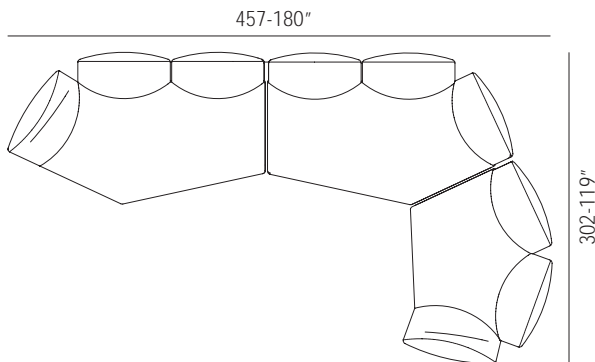

4									
35023	1	4.318	4.478	4.865	5.059	5.156	5.908	7.021	8.516
35016	1	4.162	4.318	4.692	4.880	4.974	5.719	6.727	8.255
35026	1	3.825	3.966	4.303	4.472	4.556	5.137	6.042	7.349
Totale / Total		12.304	12.761	13.859	14.410	14.685	16.763	19.789	24.119

I prezzi sono espressi in Euro
Prices are in Euro

Consultare condizione di vendita e avvertenze importanti
Please check our sale conditions and important remarks



Descrizione prodotto
Poltroncina, divani

Caratteristiche tecniche

Struttura: Telaio in multistrato di pioppo con struttura portante in metallo.

Molleggio: Nastri elastici unidirezionali ad alta portata.

Imbottitura: Poliuretano espanso a quote differenziate e memory ricoperto in termolegato cotone 100%.

Cuscini schienale: Fibra poliestere siliconata ricoperta da fodera in cotone 100%.

Piedi o braccioli: Massello in noce canaletto o rovere tinto moka.

Rivestimento: Rivestimento in tessuto o in pelle non sfoderabile.

Finitura rivestimento: Trapuntatura con cordolo nero.

Note particolari

All'ordine specificare finitura piedi o braccioli.

I cuscini schienali non sono compresi nel costo dei divani.

Description of the product

Small armchair, sofas

Technical features

Frame: poplar wood multilayer with iron supporting structure

Suspensions: high resistance unidirectional elastic bands

Padding: polyurethane foam with different densities and memory foam heated bonded with 100% cotton lining

Back cushions: silicone polyester fiber covered with 100% cotton lining.

Feet or arms: solid Canaletto walnut wood or moka dyed oak.

Cover: non-removable fabric or leather cover

Cover finishing: quilted with black fabric piping

Special notes

Please specify feet or arms finishing.

Back cushions are not included in the sofas price.

Produktbeschreibung

Sessel, Sofas

Technische Angaben

Gestell: aus Pappelschichtholz mit Traggestell aus Metall

Federung: mit hochbelastbaren und unidirektionalen Gurten

Polsterung: Polyurethanschaumstoff in verschiedenen Quoten und Memory mit thermisch gebundenen Fasern und 100% Baumwollbezug

Rückenkissen: Silikon-Polyester-Fasern mit einem Bezug aus 100% Baumwolle

FüÙe oder Armlehnen: massiver Canaletto Walnuss oder mokkagebeizte Eiche

Bezug: in Stoff oder Leder, nicht abnehmbar.

Finishing des Bezugs: mit schwarzem Keder gesteppt.

Bemerkungen

Bei der Bestellung bitte Finishing von FüÙen oder Armlehnen angeben.

Die Rückenkissen sind extra zu bestellen.

Description du produit

Fauteuil, canapés

Caractéristiques techniques

Structure: aggloméré de peuplier avec structure en fer

Suspension: sangles élastiques unidirectionnelles à haute résistance

Rembourrage: mousse de polyuréthane de différentes densités et memory enrobé en fibre thermo moulée recouverte de coton 100%

Coussins de dossier: fibre en polyester siliconé recouverte de coton 100%

Pieds ou accoudoirs: bois noyer Canaletto ou chêne teinté moka.

Revêtement: revêtement en tissu ou en cuir. Non déhoussable.

Finition revêtement: matelassé avec passepoil noir

Remarques

A la commande spécifier finition pieds ou accoudoirs.

Les coussins de dossier ne sont pas inclus dans les canapés.

- A - Espanso densità portante / High density foam
- B - Espanso densità media / Medium density foam
- C - Espanso densità soft / Soft density foam
- D - Memory foam / Memory foam
- E - Fusto in legno / Wooden frame

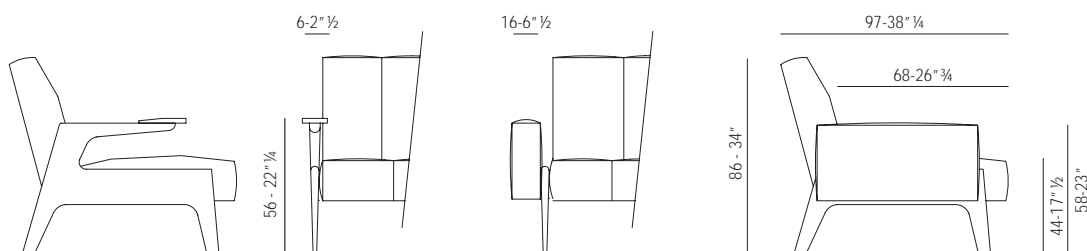
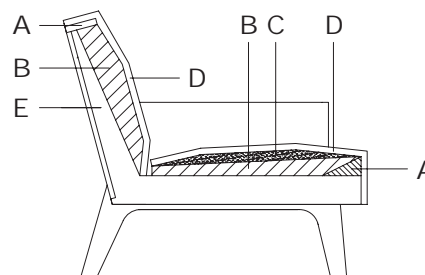

M ³	Kg.	MI.	M ²			Tessuto - Fabric					Pelle - Leather			
Volume Volume	Peso Weight	Tessuto Fabric	Pelle Leather	Imballi legno Wood packaging	Prelavaggio p. 7/10 Prewash p. 7/10		Tessuto cliente COM	D - F - Aqua	Extra	Super	Nature	Pelle cliente COL	Pelle	Pelle Lusso
							<input type="radio"/> previsto (rif. tab. pag. 3) / available: s.table p.3 <input type="radio"/> incluso / included							



50013

0,04	3	1,2	2,5												
							Rivestimento / Replacement cover	311	327	352	393	406	456	506	616
								182	197	223	264	272	347	385	490

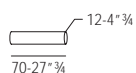

50014

0,02	2	0,8	1,6												
							Rivestimento / Replacement cover	267	280	300	339	349	405	450	550
								131	149	169	211	216	297	331	432

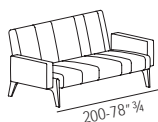

50001

1,7	55	9	13	'											
								3.886	3.958	4.139	4.355	4.487	4.840	5.377	6.486

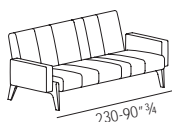

50002

1,9	65	10	15	'											
								4.085	4.162	4.359	4.581	4.719	5.089	5.655	6.818

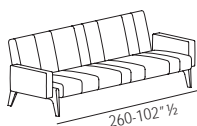

50003

2,2	75	12	16	'											
								4.301	4.381	4.592	4.824	4.969	5.357	5.952	7.179

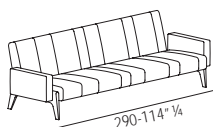

50004

2,2	75	11	16	'											
								4.781	4.869	5.101	5.360	5.520	5.952	6.614	7.977

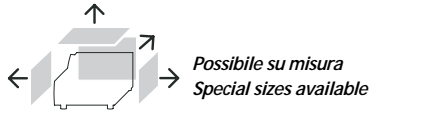
M ³	Kg.	MI.	M ²			Tessuto - Fabric					Pelle - Leather		
Volume Volume	Peso Weight	Tessuto Fabric	Pelle Leather	Imballi legno Wood packaging	Prelavaggio p. 7/10 Prewash p. 7/10								
 <p>Possibile su misura Special sizes available</p>						Tessuto cliente COM	D - F - Aqua	Extra	Super	Nature	Pelle cliente COL	Pelle	Pelle Lusso
						<input type="radio"/> previsto (rif. tab. pag. 3) / available: s.table p.3 incluso / included							



50005

0,7	30	5	8	'		2.782	2.845	3.057	3.208	3.305	3.509	3.899	4.669
-----	----	---	---	---	--	-------	-------	-------	-------	-------	-------	-------	-------

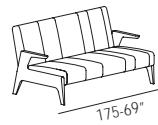

50006

1,5	45	7	11	'		4.098	4.164	4.346	4.543	4.679	4.946	5.496	6.583
-----	----	---	----	---	--	-------	-------	-------	-------	-------	-------	-------	-------

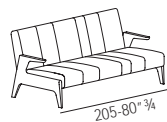

50007

1,7	55	8	13	'		4.369	4.435	4.563	4.722	4.863	5.211	5.789	6.921
-----	----	---	----	---	--	-------	-------	-------	-------	-------	-------	-------	-------

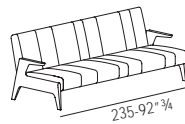

50008

2	65	10	14	'		4.586	4.656	4.791	4.959	5.107	5.396	5.995	7.159
---	----	----	----	---	--	-------	-------	-------	-------	-------	-------	-------	-------

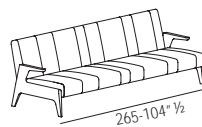

50009

2,4	85	13	18	'		5.072	5.152	5.305	5.490	5.654	5.990	6.656	7.932
-----	----	----	----	---	--	-------	-------	-------	-------	-------	-------	-------	-------



50010

0,5	20	3	6	'		2.871	2.938	3.154	3.311	3.409	3.624	4.026	4.806
-----	----	---	---	---	--	-------	-------	-------	-------	-------	-------	-------	-------

I prezzi sono espressi in Euro
Prices are in Euro

Consultare condizione di vendita e avvertenze importanti
Please check our sale conditions and important remarks



Descrizione prodotto

Divani, divano curvo, elementi centrali, terminali, chaises longues, angoli, pouf

Caratteristiche tecniche

Divani

Struttura: massello di abete e legno multistrato

Molleggio: nastri elastici unidirezionali ad alta portata

Imbottitura: poliuretano espanso a quote differenziate ricoperto in termolegato cotone 100%

Piedi: tecnici neri

Rivestimento: in tessuto o in pelle. Rivestimento in tessuto completamente sfoderabile

Opzioni:

- **ripiano pouf:** rovere tinto moka o noce Canaletto o legno laccato opaco o lucido (colori RAL a catalogo)

- **cuscino pesato:** poliuretano espanso di differenti densità, base interna con lastra in metallo

- **cuscini schienale:** in fibra poliestere siliconata ricoperta da fodera cotone 100%.

Note particolari

All'ordine specificare tipo finitura ripiano pouf.

I cuscini schienale non sono compresi nel costo dei divani.

Description of the product

Sofas, curved sofa, middle elements, end elements, chaises longues, corner elements, ottoman

Technical features

Sofas

Frame: solid fir-wood and multilayer

Springing: high resistance unidirectional elastic bands

Seat and backrest padding: polyurethane foam with different densities covered with heated bonded with 100% cotton lining

Feet: black standard

Cover: fabric or leather cover.

Fabric cover completely removable

Options

- **ottoman top:** moka dyed oak or Canaletto walnut wood or matt or glossy lacquered wood (RAL colours on catalog)

- **weighted cushion:** polyurethane foam with different densities inner base with metal slab

- **back cushions:** silicone polyester fibre covered with 100% cotton lining

Special notes:

On order please specify ottoman top finish.

Back cushions are not included in the sofas price.

Produktbeschreibung

Sofas, gebogenes Sofa, Elemente, Schlusselement, Chaises longues, Eckelemente, Hocker.

Technische Angaben

Sofas

Gestell: aus massivem Fichtenholz und Schichtholz

Federung: mit hochbelastbaren und unidirektionalen elastischen Gurten

Polsterung: Polyurethanschaumstoff in verschiedenen Quoten und Memory mit thermisch gebundenen Fasern und 100% Baumwollbezug.

FüÙe: Standard Schwarz

Bezug: Bezug aus Stoff oder Leder.

Stoffbezug ganz abnehmbar

Optionen

- **Ablage f. Hocker:** mokkagebeizte Eiche o. Canaletto Walnuss o. lackiertes Holz, matt oder glänzend (Farbmuster im Katalog)

- **Beschwertes Rückenissen:**

Polyurethanschaumstoff in verschiedenen Quoten mit innerer Metallplatte.

- **Rückenissen:** Silikon-Polyester-Fasern mit einem Bezug aus 100% Baumwolle.

Bemerkungen

Bei der Bestellung bitte Finish für die Hockerablage angeben.

Die Rückenissen sind extra zu bestellen.

Description du produit

Canapés, canapé incurvé, éléments centraux, éléments terminaux, chaises longues, angles, pouf.

Caractéristiques techniques

Structure: sapin massif et multiplis

Suspension: sangles élastiques unidirectionnelles à haute résistance

Rembourrage assise et dossier: mousse de polyuréthane de différentes densités enrobée en fibre thermomoullée recouverte de coton 100%

Pieds: standard noirs

Revêtement: en tissu ou en cuir.

Revêtement en tissu entièrement déhoussable

Options

- **plateau du pouf:** chêne teinté ou noyer Canaletto ou bois laqué brillant ou mat (pour coloris voir catalogue)

- **coussin lesté:** mousse de polyuréthane de différentes densités avec plateau en métal à l'intérieur.

- **coussin dossier:** fibre e polyester siliconé recouverte de coton 100%

Remarques

A la commande spécifier la finition pour plateau du pouf.

Les coussins de dossier ne sont pas inclus dans le prix de canapé.

- A - Espanso densità media / Medium density foam
- B - Espanso densità portante / Foam supporting density
- C - Espanso densità soft / Soft density foam
- L - Fusto in legno / Wooden frame

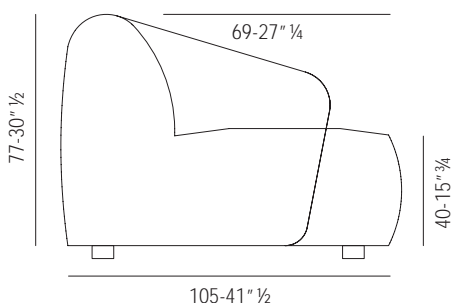
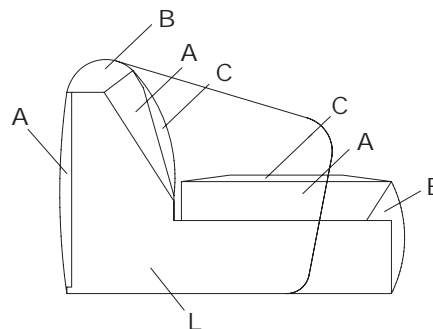

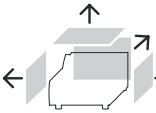
M ³	Kg.	MI.	M ²			Tessuto - Fabric					Pelle - Leather			
Volume Volume	Peso Weight	Tessuto Fabric	Pelle Leather	Imballi legno Wood packaging	Prelavaggio p. 7/10 Prewash p. 7/10	 Possibile su misura Special sizes available	Tessuto cliente COM	D - F - Aqua	Extra	Super	Nature	Pelle cliente COL	Pelle	Pelle Lusso
							<input type="radio"/> previsto (rif. tab. pag. 3) / available: s.table p.3 <input type="radio"/> incluso / included							

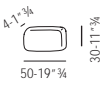
														
0,03	2	0,8	0,8		+10%	85001	196	200	212	216	226	277	308	368
						Rivestimento / Replacement cover	136	144	155	160	168	221	251	312

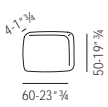
														
0,04	4	1	1,4		+10%	85002	265	272	285	327	338	377	420	504
						Rivestimento / Replacement cover	166	173	188	231	238	298	331	415

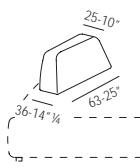
														
0,12	12	1,5	2,5		+10%	85003	566	565	579	615	633	714	793	896
						Rivestimento / Replacement cover	245	252	270	302	312	412	489	592

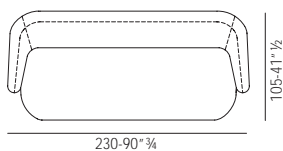
														
2,1	63	14	18		+10%	85004	4.772	4.928	5.240	5.764	5.937	6.742	7.492	9.288
						Rivestimento / Replacement cover	1.911	2.148	2.458	2.983	3.156			

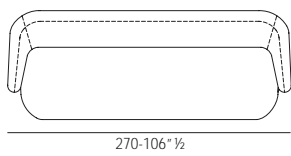
														
2,4	71	16	21		+10%	85005	5.510	5.691	6.050	6.654	6.854	7.784	8.649	10.724
						Rivestimento / Replacement cover	2.205	2.480	2.839	3.442	3.642			

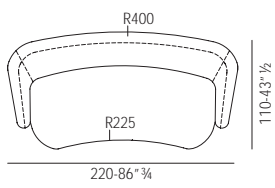
														
2,1	63	15	19		+10%	85006	5.026	5.193	5.767	6.071	6.255	7.103	7.894	9.787
						Rivestimento / Replacement cover	2.013	2.264	2.839	3.142	3.326			

I prezzi sono espressi in Euro
Prices are in Euro

Consultare condizione di vendita e avvertenze importanti
Please check our sale conditions and important remarks

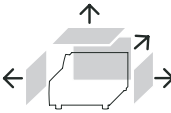
M ³	Kg.	MI.	M ²			 <i>Possibile su misura</i> <i>Special sizes available</i>	Tessuto - Fabric					Pelle - Leather		
Volume	Peso	Tessuto	Pelle	Imballi legno	Prelavaggio p. 7/10		<input type="radio"/> previsto (rif. tab. pag. 3) / available: s.table p.3 <input type="radio"/> incluso / included	Tessuto cliente	D - F - Aqua	Extra	Super	Nature	Pelle cliente	Pelle
Volume	Weight	Fabric	Leather	Wood packaging	Prewash p. 7/10		COM					COL		

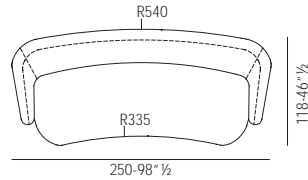

2,4	71	18	23	'	+10%	85007		5.585	5.771	6.407	6.745	6.949	7.893	8.770	10.874
							Rivestimento / Replacement cover	2.234	2.514	3.151	3.489	3.693			

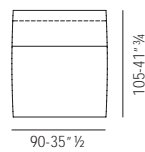

0,9	26	7	8,5	'	+10%	85008		2.520	2.600	2.766	3.042	3.132	3.557	3.951	4.900
							Rivestimento / Replacement cover	1.008	1.131	1.296	1.574	1.664			

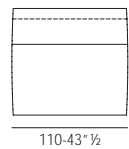

1,1	31	8	11	'	+10%	85050		2.625	2.645	2.882	3.169	3.263	3.706	4.117	5.107
							Rivestimento / Replacement cover	1.050	1.115	1.352	1.638	1.734			

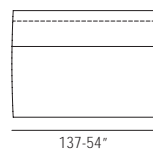

1,2	37	8	11	'	+10%	85009		2.730	2.820	2.998	3.297	3.396	3.856	4.284	5.313
							Rivestimento / Replacement cover	1.093	1.231	1.408	1.708	1.807			

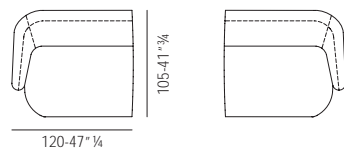

1,1	32	9	12	'	+10%	85011	85010	3.029	3.129	3.326	3.657	3.768	4.279	4.754	5.889
							Rivestimento / Replacement cover	1.212	1.365	1.560	1.892	2.002			

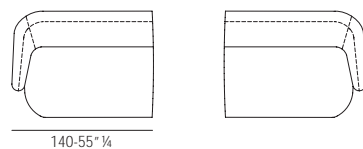

1,2	37	10	13	'	+10%	85013	85012	3.180	3.286	3.492	3.842	3.956	4.492	4.991	6.183
							Rivestimento / Replacement cover	1.273	1.433	1.638	1.988	2.104			

I prezzi sono espressi in Euro
Prices are in Euro

Consultare condizione di vendita e avvertenze importanti
Please check our sale conditions and important remarks

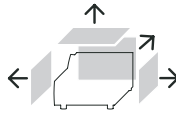
M ³	Kg.	MI.	M ²			Tessuto - Fabric					Pelle - Leather			
Volume	Peso	Tessuto	Pelle	Imballi legno	Prelavaggio p. 7/10	 Possibile su misura Special sizes available	Tessuto cliente	D - F - Aqua	Extra	Super	Nature	Pelle cliente	Pelle	Pelle Lusso
Volume	Weight	Fabric	Leather	Wood packaging	Prewash p. 7/10		COM					COL		
						<input type="radio"/> previsto (rif. tab. pag. 3) / available: s.table p.3 <input type="radio"/> incluso / included								

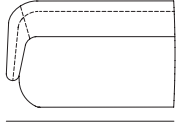
						 167-65 ¹ / ₄								
						85015		85014						
1,5	45	11,5	15	'	+10%		3.402	3.516	3.736	4.115	4.235	4.806	5.341	6.616
							Rivestimento / Replacement cover	1.362	1.534	1.754	2.131	2.252		

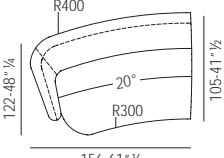
						 122-48 ¹ / ₄ 20° R300 105-41 ¹ / ₂ 156-61 ¹ / ₂								
						85017		85016						
1,5	45	12,5	16,5	'	+10%		3.828	3.956	4.204	4.630	4.763	5.407	6.008	7.443
							Rivestimento / Replacement cover	1.533	1.726	1.974	2.398	2.533		

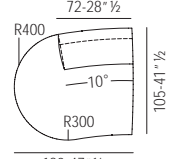
						 72-28 ¹ / ₂ R400 10° R300 105-41 ¹ / ₂ 120-47 ¹ / ₄								
						85019		85018						
1,1	32	7,5	9	'	+10%		2.665	2.754	2.927	3.219	3.315	3.766	4.184	5.181
							Rivestimento / Replacement cover	1.068	1.202	1.375	1.668	1.764		

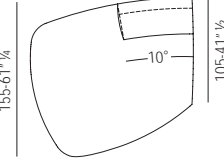
						 155-61 ¹ / ₄ 10° R300 105-41 ¹ / ₂ 155-61 ¹ / ₄								
						85021		85020						
2,3	69	12	15	'	+10%		3.937	4.067	4.323	4.757	4.898	5.563	6.180	7.652
							Rivestimento / Replacement cover	1.576	1.775	2.030	2.462	2.605		

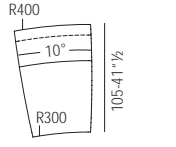
						 R400 10° R300 105-41 ¹ / ₂ 75-29 ³ / ₄								
						85022								
1,3	38	8,5	12	'	+10%		3.139	3.245	3.447	3.795	3.906	4.433	4.927	6.105
							Rivestimento / Replacement cover	1.256	1.415	1.619	1.966	2.076		

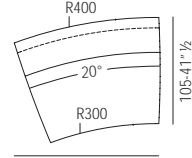
						 R400 20° R300 105-41 ¹ / ₂ 142-56								
						85023								
1,3	40	10	14	'	+10%		3.252	3.364	3.573	3.936	4.048	4.596	5.107	6.326
							Rivestimento / Replacement cover	1.302	1.469	1.678	2.040	2.153		

I prezzi sono espressi in Euro
 Prices are in Euro

Consultare condizione di vendita e avvertenze importanti
 Please check our sale conditions and important remarks

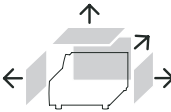
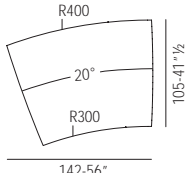
M ³	Kg.	MI.	M ²			Tessuto - Fabric					Pelle - Leather			
Volume	Weight	Fabric	Leather	Imballi legno	Prelavaggio p. 7/10	 <p>Possibile su misura Special sizes available</p>	Tessuto cliente	D - F - Aqua	Extra	Super	Nature	Pelle cliente	Pelle	Pelle Lusso
Volume	Weight	Fabric	Leather	Wood packaging	Prewash p. 7/10		COM					COL		
														
						<p>○ previsto (rif. tab. pag. 3) / available: s.table p.3 incluso / included</p>								

0,7	22	7	8,5	'	+10%	85024	Rivestimento / Replacement cover	2.506	2.590	2.752	3.031	3.118	3.539	3.933	4.872
-----	----	---	-----	---	------	-------	----------------------------------	-------	-------	-------	-------	-------	-------	-------	-------

1,6	47	10	14	'	+10%	85025	Rivestimento / Replacement cover	4.523	4.675	4.968	5.471	5.629	6.390	7.100	8.797
-----	----	----	----	---	------	-------	----------------------------------	-------	-------	-------	-------	-------	-------	-------	-------

2,9	87	14	20	'	+10%	85026	Rivestimento / Replacement cover	5.203	5.376	5.713	6.289	6.472	7.347	8.165	10.117
-----	----	----	----	---	------	-------	----------------------------------	-------	-------	-------	-------	-------	-------	-------	--------

1,9	57	12	16	'	+10%	85028	85027	Rivestimento / Replacement cover	4.321	4.467	4.745	5.220	5.376	6.105	6.784	8.403
-----	----	----	----	---	------	-------	-------	----------------------------------	-------	-------	-------	-------	-------	-------	-------	-------

2	60	12	16	'	+10%	85030	85029	Rivestimento / Replacement cover	4.667	4.824	5.124	5.638	5.806	6.605	7.326	9.076
---	----	----	----	---	------	-------	-------	----------------------------------	-------	-------	-------	-------	-------	-------	-------	-------

2,9	87	16	21	'	+10%	85032	85031	Rivestimento / Replacement cover	5.203	5.376	5.713	6.289	6.472	7.347	8.165	10.117
-----	----	----	----	---	------	-------	-------	----------------------------------	-------	-------	-------	-------	-------	-------	-------	--------

I prezzi sono espressi in Euro
Prices are in Euro

Consultare condizione di vendita e avvertenze importanti
Please check our sale conditions and important remarks

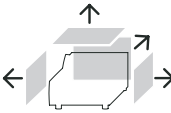
M ³	Kg.	MI.	M ²			Tessuto - Fabric					Pelle - Leather			
Volume Volume	Peso Weight	Tessuto Fabric	Pelle Leather	Imballi legno Wood packaging	Prelavaggio p. 7/10 Prewash p. 7/10	 <p>Possibile su misura Special sizes available</p>	Tessuto cliente COM	D - F - Aqua	Extra	Super	Nature	Pelle cliente COL	Pelle	Pelle Lusso
							<input type="radio"/> previsto (rif. tab. pag. 3) / available: s.table p.3 <input type="radio"/> incluso / included							

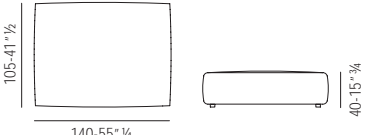
						85033									
0,7	21	7	8,5	'	+10%	Rivestimento / Replacement cover	1.567	1.620	1.721	1.892	1.950	2.215	2.459	3.050	
							628	707	809	981	1.038				

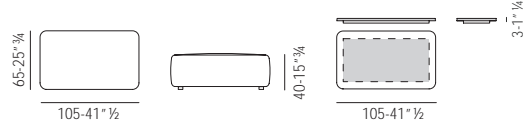
						85034								
0,3	9	3	4	'	+10%	Rivestimento / Replacement cover	1.238	1.278	1.358	1.494	1.540	1.748	1.942	2.408
						Piano legno / Wooden top	591							

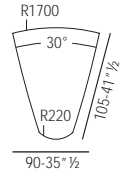
						85035								
0,3	9	3	4	'	+10%	Rivestimento / Replacement cover	1.607	1.637	1.718	1.853	1.909	2.097	2.292	2.756
							643	702	780	915	972			

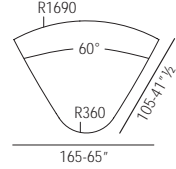
						85036								
0,8	24	5	7,5	'	+10%	Rivestimento / Replacement cover	3.052	3.110	3.261	3.520	3.625	3.984	4.354	5.237
							1.222	1.331	1.482	1.741	1.846			

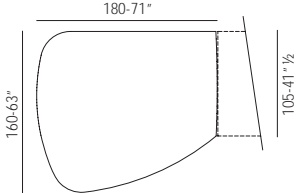
						85037								
1,5	44	8	11	'	+10%	Rivestimento / Replacement cover	4.044	4.179	4.443	4.884	5.031	5.713	6.348	7.872
							1.619	1.822	2.085	2.526	2.673			

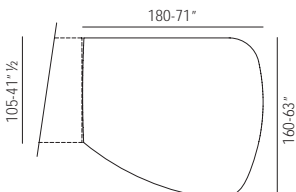
						85038								
1,5	44	8	11	'	+10%	Rivestimento / Replacement cover	4.044	4.179	4.443	4.884	5.031	5.713	6.348	7.872
							1.619	1.822	2.085	2.526	2.673			

I prezzi sono espressi in Euro
Prices are in Euro

Consultare condizione di vendita e avvertenze importanti
Please check our sale conditions and important remarks

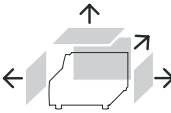
M ³	Kg.	MI.	M ²			Tessuto - Fabric					Pelle - Leather			
Volume	Peso	Tessuto	Pelle	Imballi legno	Prelavaggio p. 7/10	 Possibile su misura Special sizes available	Tessuto cliente	D - F - Aqua	Extra	Super	Nature	Pelle cliente	Pelle	Pelle Lusso
Volume	Weight	Fabric	Leather	Wood packaging	Prewash p. 7/10		COM					COL		
						<input type="checkbox"/> previsto (rif. tab. pag. 3) / available: s.table p.3 <input type="checkbox"/> incluso / included								

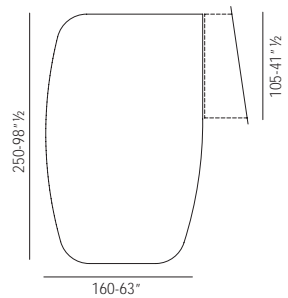

1,5	44	8	11	'	+10%	85039		4.247	4.388	4.664	5.129	5.283	5.998	6.665	8.266
							Rivestimento / Replacement cover	1.696	1.912	2.189	2.652	2.807			

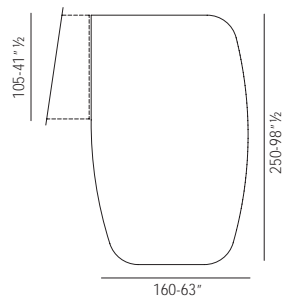

1,5	44	8	11	'	+10%	85040		4.247	4.388	4.664	5.129	5.283	5.998	6.665	8.266
							Rivestimento / Replacement cover	1.697	1.912	2.189	2.652	2.807			

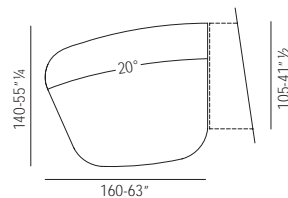

1,1	34	6	8,5	'	+10%	85041		3.803	3.929	4.175	4.593	4.729	5.370	5.966	7.399
							Rivestimento / Replacement cover	1.524	1.715	1.962	2.377	2.515			

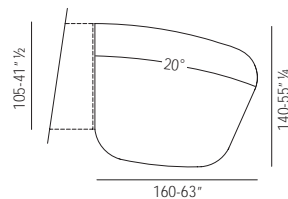

1,1	34	6	8,5	'	+10%	85042		3.803	3.929	4.175	4.593	4.729	5.370	5.966	7.399
							Rivestimento / Replacement cover	1.524	1.715	1.962	2.377	2.515			

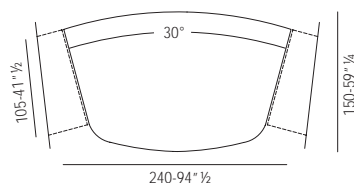

1,4	41	8	11	'	+10%	85043		4.164	4.304	4.574	5.031	5.183	5.884	6.539	8.107
							Rivestimento / Replacement cover	1.667	1.877	2.148	2.605	2.756			

I prezzi sono espressi in Euro
Prices are in Euro

Consultare condizione di vendita e avvertenze importanti
Please check our sale conditions and important remarks

M ³	Kg.	MI.	M ²			Tessuto - Fabric					Pelle - Leather		
Volume Volume	Peso Weight	Tessuto Fabric	Pelle Leather	Imballi legno Wood packaging	Prelavaggio p. 7/10 Prewash p. 7/10	Tessuto cliente COM	D - F - Aqua	Extra	Super	Nature	Pelle cliente COL	Pelle	Pelle Lusso

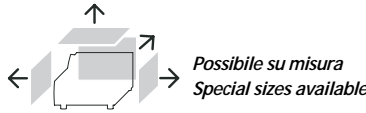

○ previsto (rif. tab. pag. 3) / available: s.table p.3
incluso / included

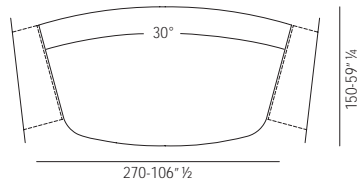

1,7	50	9,5	13	'	+10%	85044	4.373	4.519	4.804	5.283	5.443	6.179	6.866	8.513
						Rivestimento / Replacement cover	1.750	1.971	2.255	2.736	2.895			

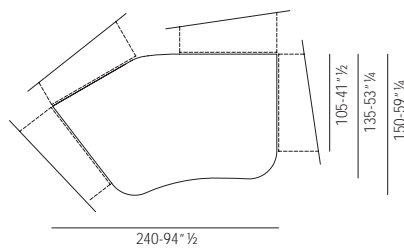

1,5	45	8,5	12	'	+10%	85045	4.164	4.304	4.574	5.031	5.183	5.884	6.539	8.107
						Rivestimento / Replacement cover	1.667	1.877	2.148	2.605	2.756			

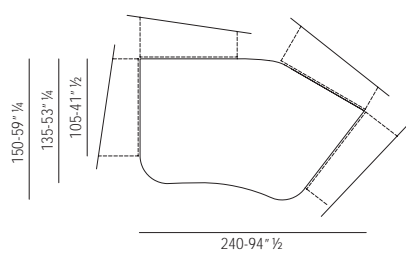

1,5	45	8,5	12	'	+10%	85046	4.164	4.304	4.574	5.031	5.183	5.884	6.539	8.107
						Rivestimento / Replacement cover	1.667	1.877	2.148	2.605	2.756			

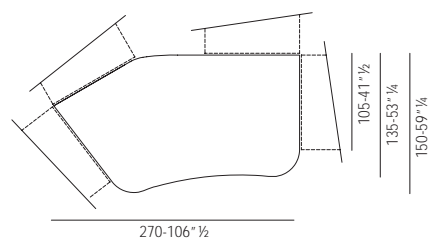

1,8	54	10,5	14	'	+10%	85047	4.373	4.519	4.804	5.283	5.443	6.179	6.866	8.513
						Rivestimento / Replacement cover	1.750	1.971	2.255	2.736	2.895			

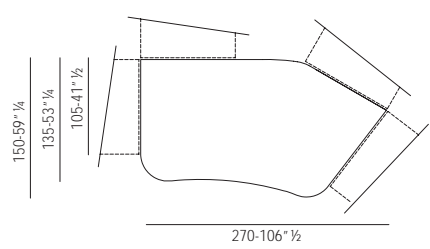

1,8	54	10,5	14	'	+10%	85048	4.373	4.519	4.804	5.283	5.443	6.179	6.866	8.513
						Rivestimento / Replacement cover	1.750	1.971	2.255	2.736	2.895			

I prezzi sono espressi in Euro
Prices are in Euro

Consultare condizione di vendita e avvertenze importanti
Please check our sale conditions and important remarks

Il totale delle composizioni potrà non corrispondere a causa di arrotondamenti automatici.

The total amount in compositions may not correspond to the sum of single prices due to automatic rounding.

Q.tà / Qty / Q.té / Stk	Tessuto - Fabric					Pelle - Leather		
	Tessuto cliente COM	D - F - Aqua	Extra	Super	Nature	Pelle cliente COL	Pelle	Pelle Lusso

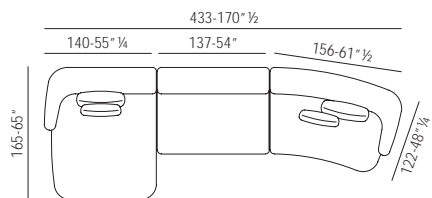

85001	2	391	400	423	432	451	553	615	735
85002	2	529	543	569	654	675	754	839	1.008
85028	1	4.321	4.467	4.745	5.220	5.376	6.105	6.784	8.403
85009	1	2.730	2.820	2.998	3.297	3.396	3.856	4.284	5.313
85016	1	3.828	3.956	4.204	4.630	4.763	5.407	6.008	7.443
Totale / Total									
11.798 12.185 12.936 14.231 14.659 16.668 18.528 22.901									

1

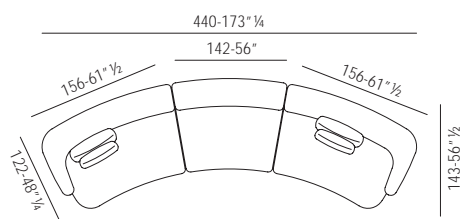

85001	2	391	400	423	432	451	553	615	735
85002	2	529	543	569	654	675	754	839	1.008
85017	1	3.828	3.956	4.204	4.630	4.763	5.407	6.008	7.443
85023	1	3.252	3.364	3.573	3.936	4.048	4.596	5.107	6.326
85016	1	3.828	3.956	4.204	4.630	4.763	5.407	6.008	7.443
Totale / Total									
11.827 12.218 12.908 14.280 14.697 16.715 18.574 22.954									

2

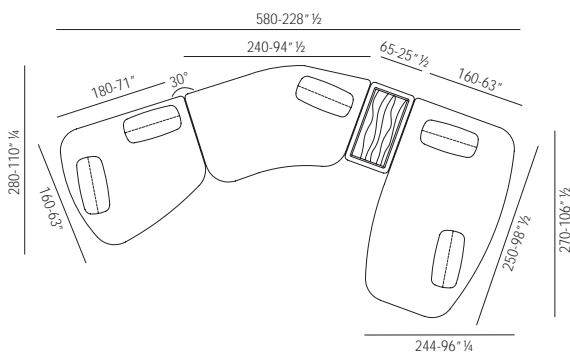

85003	5	2.823	2.821	2.888	3.065	3.162	3.565	3.959	4.473
85037	1	4.044	4.179	4.443	4.884	5.031	5.713	6.348	7.872
85046	1	4.164	4.304	4.574	5.031	5.183	5.884	6.539	8.107
85034	1	1.238	1.278	1.358	1.494	1.540	1.748	1.942	2.408
suppl.	1	591							
85040	1	4.247	4.388	4.664	5.129	5.283	5.998	6.665	8.266
Totale / Total									
17.105 17.559 18.515 20.190 20.787 23.497 26.041 31.713									

3

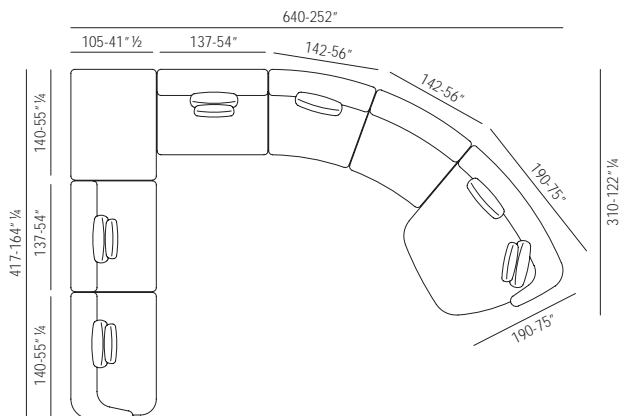

85001	4	781	800	846	864	901	1.105	1.229	1.470
85002	6	1.587	1.629	1.705	1.962	2.024	2.260	2.516	3.022
85013	1	3.180	3.286	3.492	3.842	3.956	4.492	4.991	6.183
85009	1	2.730	2.820	2.998	3.297	3.396	3.856	4.284	5.313
85033	1	1.567	1.620	1.721	1.892	1.950	2.215	2.459	3.050
85009	1	2.730	2.820	2.998	3.297	3.396	3.856	4.284	5.313
85023	2	6.503	6.727	7.145	7.871	8.095	9.192	10.213	12.652
85031	1	5.203	5.376	5.713	6.289	6.472	7.347	8.165	10.117
Totale / Total									
24.277 25.074 26.615 29.311 30.188 34.319 38.140 47.118									

4

I prezzi sono espressi in Euro
Prices are in Euro

Consultare condizione di vendita e avvertenze importanti
Please check our sale conditions and important remarks

**Descrizione prodotto**

Divani, divani componibili, chaises longues, pouf.

Caratteristiche tecniche

Struttura: Massello di pino e supporti in ferro per schienali e base.

Molleggio: Nastri elastici unidirezionali ad alta portata.

Imbottitura: Poliuretano espanso ricoperto con resinato accoppiato vellutino.

Cuscini seduta: Inserto in poliuretano espanso avvolto da materassina in piuma con fodera a sezioni separate.

Cuscini schienale: Piuma lavata e sterilizzata con fodera a sezioni separate e con tampone interno in poliuretano espanso.

Cuscini poggiatesta: Fibra poliestere siliconata ricoperta da fodera in cotone 100%.

Piedi: Metallo nickel nero o con puntale ottone.

Rivestimento: Rivestimento in tessuto o in pelle. Rivestimento in tessuto completamente sfoderabile.

Note particolari

Schienali e braccioli smontabili. Alla consegna i piedi sono smontati.

Description of the product

Sofas, unit sofas, chaises longues, ottoman

Technical features

Frame: Solid poplar wood and iron supports for back and frame.

Springing: High resistance unidirectional elastic bands.

Padding: Polyurethane foam covered with heated bonded polyester fibre.

Seat cushions: Core in polyurethane foam covered with a feather layer in separate sections.

Back cushions: Core in polyurethane foam covered with a feather layer in separate sections.

Backrest cushions: Silicone polyester fibre covered with 100% cotton lining.

Feet: Black nickel steel or brass tip.

Cover: Fabric or leather. Fabric cover completely removable.

Special notes

Backrest and arms can be disassembled.

Sofas are delivered with disassembled feet.

Produktbeschreibung

Sofas, Anbauelemente, Chaises longues, Hocker

Technische Angaben

Gestell: Aus massivem Pappelholz mit Eisenbeschlägen für Rückenlehne und Sitzgestell.

Federung: Mit hochbelastbaren und unidirektionalen elastischen Gurten.

Polsterung: Polyurethanschaumstoff mit thermisch gebundenen Fasern und samtartiger Resinatabdeckung.

Sitzkissen: Polyurethanschaumstoffeinlage mit Daunen in separaten Kammern bezogen.

Rückenkissen: Polyurethanschaumstoffkern mit gewaschenen und sterilisierten Daunen in separaten Kammern bezogen.

Rückenstützkissen: Silikon-Polyester-Fasern mit einem Bezug aus 100% Baumwolle.

FüÙe: Schwarzvernickeltes Metall oder mit Fußspitzen aus Messing.

Bezug: Bezug aus Stoff oder Leder. Stoffbezug ganz abnehmbar.

Bemerkungen

Rücken- u. Armlehnen demontierbar.

Bei der Lieferung Sind die FüÙe nicht montiert.

Description du produit

Canapés, canapés modulables, chaises longues, pouf

Caractéristiques techniques

Structure: Peuplier massif avec connecteurs en fer pour dossiers et base.

Suspension: Sangles élastiques unidirectionnelles à haute résistance.

Rembourrage: Mousse de polyuréthane de différentes densités, enrobée en fibre thermomoullée.

Coussins d' assise: Mousse de polyuréthane enrobée d'un matelas en plume lavée et stérilisée en sections distinctes.

Coussins de dossier: Plume lavée et stérilisée en sections distinctes avec élément intercalaire en mousse.

Coussins appuie-reins: Fibre en polyester siliconé recouverte de coton 100%.

Pieds: Acier nickel noir ou avec embout en laiton

Revêtement: Revêtement en tissu ou en cuir. Revêtement en tissu entièrement déhoussable.

Remarques

Dos et accoudoirs amovibles.

A la livraison les pieds sont demontés.

B - Espanso densità portante / Foam supporting density

C - Espanso densità soft / Foam soft density

L - Fusto in legno / Wooden frame

P - Piuma / Feather

R - Resinato / Heated bonded polyester fibre

S - Fibra poliestere siliconata / Silicone polyester fibre

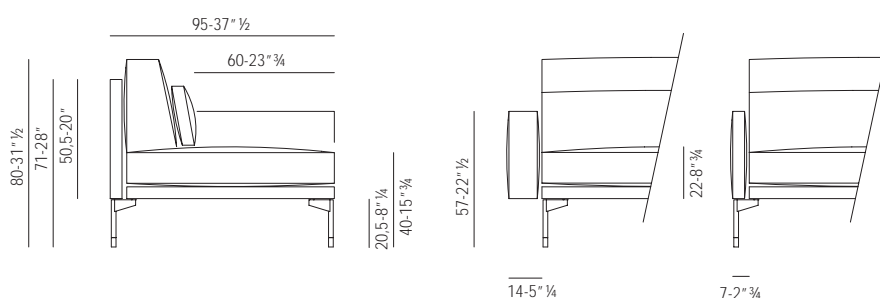
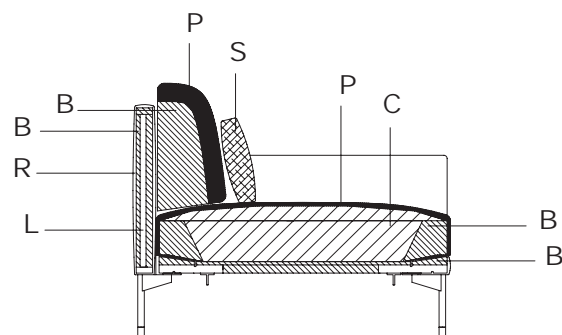

110-Modern

design Gianluigi Landoni

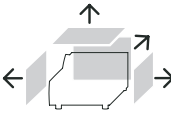
M ³	Kg.	MI.	M ²			 <i>Possibile su misura</i> <i>Special sizes available</i>	Tessuto - Fabric					Pelle - Leather		
Volume Volume	Peso Weight	Tessuto Fabric	Pelle Leather	Imballi legno Wood packaging	Prelavaggio p. 7/10 Prewash p. 7/10		<input type="radio"/> previsto (rif. tab. pag. 3) / available: s.table p.3 <input type="radio"/> incluso / included	Tessuto cliente COM	D - F - Aqua	Extra	Super	Nature	Pelle cliente COL	Pelle

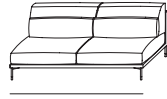

192-75*¾

110001

1,20	80	14,5	20	'	+10%		3.768	3.921	4.076	4.238	4.365	4.929	5.476	6.460
						Rivestimento / Replacement cover	1.795	1.947	2.104	2.265	2.335			

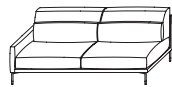

199-78*½

110003

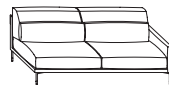

110002

1,20	90	15,5	21,7	'	+10%		4.165	4.356	4.575	4.820	4.965	5.592	6.212	7.396
						Rivestimento / Replacement cover	2.006	2.196	2.417	2.659	2.740			

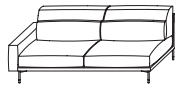

206-81*¾

110005

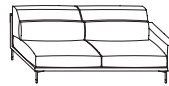

110004

1,30	90	15,8	22	'	+10%		4.191	4.385	4.607	4.856	5.003	5.631	6.257	7.455
						Rivestimento / Replacement cover	2.019	2.213	2.436	2.685	2.767			

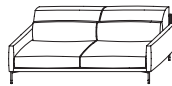

206-81*¾

110012

1,30	100	16,5	23,4	'	+10%		4.565	4.793	5.077	5.400	5.562	6.253	6.947	8.334
						Rivestimento / Replacement cover	2.217	2.448	2.729	3.055	3.147			

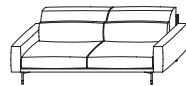

220-86*¾

110013

1,40	100	17,1	24	'	+10%		4.611	4.849	5.139	5.473	5.637	6.335	7.038	8.448
						Rivestimento / Replacement cover	2.244	2.479	2.770	3.104	3.195			

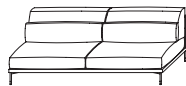

222-87*½

110014

1,40	93	15,5	22,5	'	+10%		3.956	4.115	4.277	4.451	4.584	5.174	5.749	6.785
						Rivestimento / Replacement cover	1.884	2.044	2.208	2.377	2.448			

I prezzi sono espressi in Euro
Prices are in Euro

Consultare condizione di vendita e avvertenze importanti
Please check our sale conditions and important remarks

110-Modern

design Gianluigi Landoni

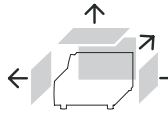
M ³	Kg.	MI.	M ²			Tessuto - Fabric					Pelle - Leather		
Volume Volume	Peso Weight	Tessuto Fabric	Pelle Leather	Imballi legno Wood packaging	Prelavaggio p. 7/10 Prewash p. 7/10								
 <p>Possibile su misura Special sizes available</p>						Tessuto cliente COM	D - F - Aqua	Extra	Super	Nature	Pelle cliente COL	Pelle	Pelle Lusso
						<input type="radio"/> previsto (rif. tab. pag. 3) / available: s.table p.3 incluso / included							

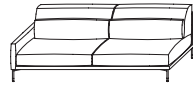

229-90" ¼

110016

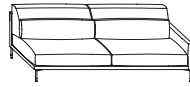

110015

1,40	103	16,5	24,2	'	+10%		4.354	4.554	4.780	5.031	5.180	5.837	6.485	7.721
						Rivestimento / Replacement cover	2.097	2.294	2.522	2.774	2.857			

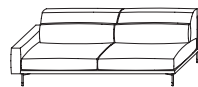

236-93"

110018

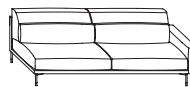

110017

1,50	103	16,8	24	'	+10%		4.378	4.578	4.811	5.066	5.218	5.878	6.531	7.778
						Rivestimento / Replacement cover	2.110	2.310	2.541	2.799	2.882			

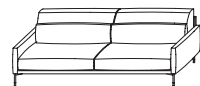

236-93"

110025

1,50	113	17,5	25,9	'	+10%		4.751	4.989	5.279	5.611	5.781	6.500	7.222	8.656
						Rivestimento / Replacement cover	2.308	2.544	2.834	3.169	3.263			



250-98" ½

110026

1,60	113	18,1	26,5	'	+10%		4.801	5.044	5.342	5.685	5.856	6.581	7.312	8.773
						Rivestimento / Replacement cover	2.334	2.575	2.874	3.216	3.313			

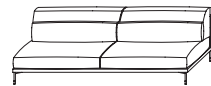

252-99" ¼

110027

1,50	106	17	24,5	'	+10%		4.051	4.214	4.380	4.557	4.693	5.297	5.886	6.946
						Rivestimento / Replacement cover	1.931	2.091	2.260	2.435	2.508			

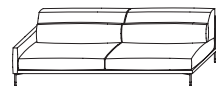

259-102"

110029

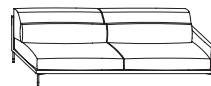

110028

1,50	116	18	26,2	'	+10%		4.448	4.649	4.882	5.138	5.293	5.961	6.623	7.882
						Rivestimento / Replacement cover	2.140	2.343	2.574	2.830	2.915			

I prezzi sono espressi in Euro
Prices are in Euro

Consultare condizione di vendita e avvertenze importanti
Please check our sale conditions and important remarks

110-Modern

design Gianluigi Landoni

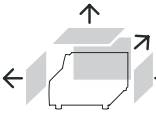
M ³	Kg.	MI.	M ²			Tessuto - Fabric					Pelle - Leather			
Volume Volume	Peso Weight	Tessuto Fabric	Pelle Leather	Imballi legno Wood packaging	Prelavaggio p. 7/10 Prewash p. 7/10	 <p>Possibile su misura Special sizes available</p>	Tessuto cliente COM	D - F - Aqua	Extra	Super	Nature	Pelle cliente COL	Pelle	Pelle Lusso
							<input type="checkbox"/> previsto (rif. tab. pag. 3) / available: s.table p.3 incluso / included							

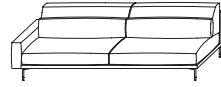

266-104*¾

110031

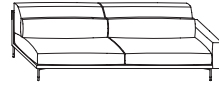

110030

1,60	116	18,3	26,5	'	+10%		4.474	4.677	4.912	5.174	5.330	6.001	6.668	7.940
						Rivestimento / Replacement cover	2.155	2.358	2.593	2.855	2.941			

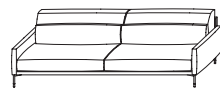

266-107*¾

110038

1,60	126	19	27,9	'	+10%		4.846	5.087	5.380	5.719	5.890	6.622	7.358	8.819
						Rivestimento / Replacement cover	2.354	2.597	2.888	3.229	3.323			

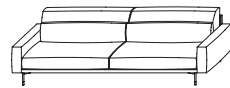

280-110*¾

110039

1,70	126	19,6	28,5	'	+10%		4.893	5.140	5.443	5.791	5.965	6.705	7.450	8.933
						Rivestimento / Replacement cover	2.376	2.624	2.926	3.274	3.372			

110-Modern

design Gianluigi Landoni

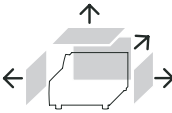
M ³	Kg.	MI.	M ²			Tessuto - Fabric					Pelle - Leather				
Volume Volume	Peso Weight	Tessuto Fabric	Pelle Leather	Imballi legno Wood packaging	Prelavaggio p. 7/10 Prewash p. 7/10	Tessuto cliente COM	D - F - Aqua	Extra	Super	Nature	Pelle cliente COL	Pelle	Pelle Lusso		
						 <p>Possibile su misura Special sizes available</p>									
						<input type="radio"/> previsto (rif. tab. pag. 3) / available: s.table p.3 incluso / included									

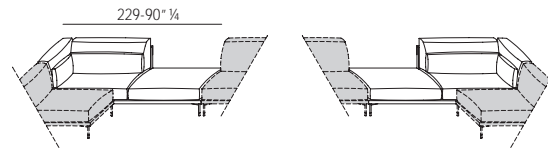

						110043	110042									
1,20	80	15,5	24	'	+10%			4.466	4.687	4.912	5.180	5.337	6.113	6.792	8.127	
								Rivestimento / Replacement cover	2.158	2.382	2.605	2.874	2.961			

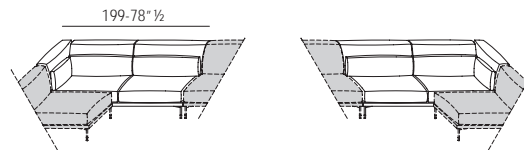

						110062	110061									
1,40	91	17,5	24,5	'	+10%			4.577	4.793	5.026	5.295	5.454	6.151	6.833	8.143	
								Rivestimento / Replacement cover	2.204	2.421	2.652	2.923	3.009			

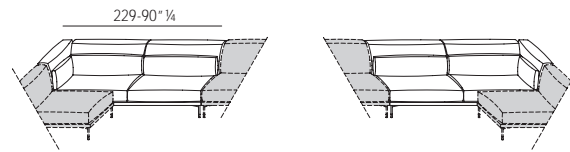

						110064	110063									
1,60	102	18,5	26,5	'	+10%			4.781	5.009	5.248	5.527	5.692	6.421	7.134	8.494	
								Rivestimento / Replacement cover	2.302	2.529	2.768	3.046	3.137			

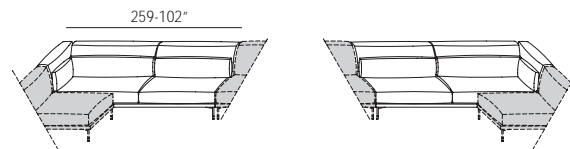

						110066	110065									
1,80	118	19,3	29	'	+10%			4.970	5.211	5.458	5.752	5.924	6.678	7.420	8.834	
								Rivestimento / Replacement cover	2.393	2.629	2.880	3.173	3.269			

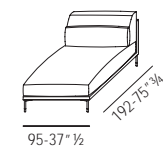

						110047										
1,20	72	10	14	'	+10%			2.873	3.013	3.156	3.329	3.429	3.927	4.364	5.222	
								Rivestimento / Replacement cover	1.388	1.527	1.673	1.846	1.902			

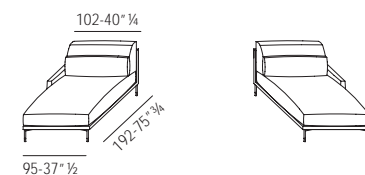

						110049	110048									
1,20	82	11	15,7	'	+10%			3.271	3.448	3.658	3.910	4.028	4.590	5.101	6.159	
								Rivestimento / Replacement cover	1.599	1.599	1.779	2.238	2.305			

I prezzi sono espressi in Euro
Prices are in Euro

Consultare condizione di vendita e avvertenze importanti
Please check our sale conditions and important remarks

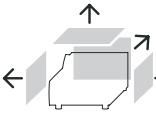
M ³	Kg.	MI.	M ²			Tessuto - Fabric					Pelle - Leather			
Volume Volume	Peso Weight	Tessuto Fabric	Pelle Leather	Imballi legno Wood packaging	Prelavaggio p. 7/10 Prewash p. 7/10	 <p>Possibile su misura Special sizes available</p>	Tessuto cliente COM	D - F - Aqua	Extra	Super	Nature	Pelle cliente COL	Pelle	Pelle Lusso
					<input type="checkbox"/> previsto (rif. tab. pag. 3) / available: s.table p.3 incluso / included									

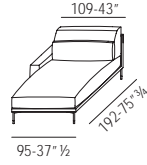

110051



110050

1,30	82	11,3	16	'	+10%		3.295	3.476	3.688	3.948	4.066	4.632	5.146	6.217
						Rivestimento / Replacement cover	1.612	1.794	2.006	2.264	2.334			



110058

0,30	26	5	7	'	+10%		1.671	1.754	1.843	1.943	2.000	2.290	2.545	3.053
						Rivestimento / Replacement cover	808	891	978	1.078	1.110			

Il totale delle composizioni potrà non corrispondere a causa di arrotondamenti automatici.

The total amount in compositions may not correspond to the sum of single prices due to automatic rounding.

Q.tà / Qty / Q.té / Stk	Tessuto - Fabric					Pelle - Leather		
	Tessuto cliente COM	D - F - Aqua	Extra	Super	Nature	Pelle cliente COL	Pelle	Pelle Lusso

1

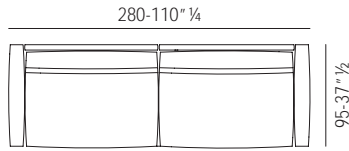

110039	1	4.893	5.140	5.443	5.791	5.965	6.705	7.450	8.933
Totale / Total		4.893	5.140	5.443	5.791	5.965	6.705	7.450	8.933

2

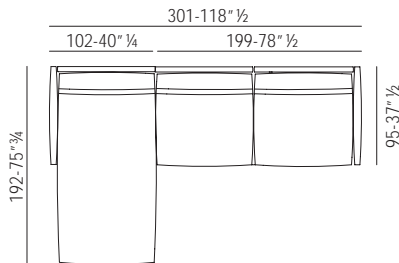

110002	1	4.165	4.356	4.575	4.820	4.965	5.592	6.212	7.396
110049	1	3.271	3.448	3.658	3.910	4.028	4.590	5.101	6.159
Totale / Total		7.435	7.804	8.232	8.729	8.991	10.182	11.313	13.554

3

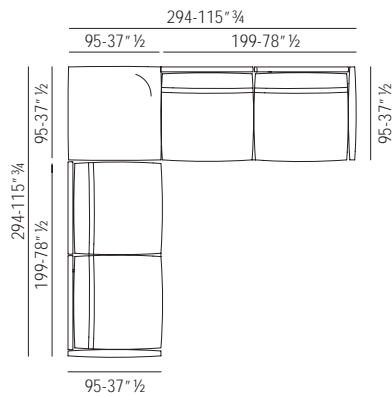

110002	1	4.165	4.356	4.575	4.820	4.965	5.592	6.212	7.396
110058	1	1.671	1.754	1.843	1.943	2.000	2.545	2.545	3.053
110003	1	4.165	4.356	4.575	4.820	4.965	6.212	6.212	7.396
Totale / Total		9.998	10.464	10.990	11.581	11.927	13.469	14.966	17.844

4

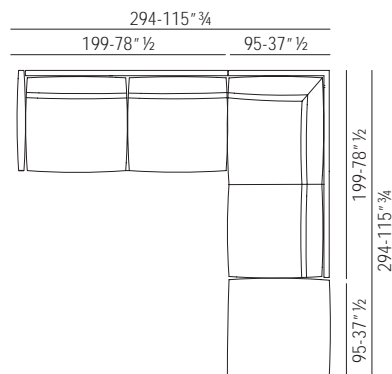

110003	1	4.165	4.356	4.575	4.820	4.965	5.592	6.212	7.396
110062	1	4.577	4.793	5.026	5.295	5.454	6.151	6.833	8.143
110058	1	1.671	1.754	1.843	1.943	2.000	2.290	2.545	3.053
Totale / Total		10.411	10.901	11.441	12.054	12.416	14.028	15.587	18.589

I prezzi sono espressi in Euro
Prices are in Euro

Consultare condizione di vendita e avvertenze importanti
Please check our sale conditions and important remarks

**Descrizione prodotto**

Isole, pouf, cuscino schienale, tavolini

Caratteristiche tecniche**Isole/pouf**

Struttura: massello di pioppo

Molleggio: nastri elastici unidirezionali ad alta portata

Seduta: poliuretano espanso a quote differenziate e memory ricoperto con fibra siliconata

Piedi: metallo nickel nero

Rivestimento: rivestimento in tessuto o in pelle. Rivestimento in tessuto completamente sfoderabile

Opzione: Cuscino schienale: poliuretano espanso di differenti densità, base interna con lastra in metallo

Tavolini

Gambe: metallo nickel nero

Piano: rovere tinto moka o noce Canaletto

Sottopiano: rovere tinto moka o noce Canaletto

Note particolari

All'ordine specificare tipo finitura piano tavolino.

Alla consegna i piedi sono smontati.

Description of the product

Oversized ottoman, ottoman, back cushion, small tables

Technical features

Frame: solid poplar

Springing: high resistance unidirectional elastic bands

Seat: polyurethane foam with different densities and memory covered with silicone polyester fibre

Feet: black nickel steel

Cover: fabric or leather. Fabric cover completely removable

Option: Back cushion: polyurethane foam with different densities inner base with metal slab.

Small tables

Feet: black nickel steel

Top: moka dyed oak or Canaletto walnut wood

Underlay: moka dyed oak or Canaletto walnut wood

Special notes

On order please specify top finish.

Sofas are delivered with disassembled feet

Produktbeschreibung

Hockerinsel, Hocker, Rückenissen, Tischchen

Technische Angaben**Hocker**

Gestell: aus massivem Pappelholz

Federung: mit hochbelastbaren und unidirektionalen elastischen Gurten

Sitz: Polyurethanschaustoff in verschiedenen Quoten und memory mit Silikonpolyesterfasern bezogen

Füße: Schwarzvernickeltes Metall

Bezug: Bezug aus Stoff oder Leder: Stoffbezug ganz abnehmbar.

Option: Rückenissen: Polyurethanschaumstoff in verschiebenen Quoten mit innerer Metallplatte.

Tischchen

Füße: Schwarzvernickeltes Metall

Platte: mokkagebeizte Eiche o. Canaletto Walnuss

Ablage: mokkagebeizte Eiche o. Canaletto Walnuss

Bemerkungen

Bei der Bestellung bitte Finish für die Platte angeben.

Bei der Lieferung sind die Füße nicht montiert.

Description du produit

Grand pouf, pouf, coussin dossier, petites tables

Caractéristiques techniques**Pouf**

Structure: peuplier massif

Suspension: sangles élastique sunidirectionelles à haute resistance

Assise: mousse de polyurethane de différentes densités et memory enrobée en fibre polyester siliconé

Pieds: acier nickel noir

Revêtement: revêtement en tissu ou en cuir. Revêtement en tissu entièrement déhoussable

Option: Coussin de dossier: mousse de polyuréthane de différentes densités avec plateau en métal à l'intérieur

Petites tables

Pieds: acier nickel noir

Plateau: chêne teinté ou noyer Canaletto

Etagère: chêne teinté ou noyer Canaletto

Remarques

A la commande spécifier la finition du plateau

A la livraison les pieds sont démontés

A - Espanso Memory / Memory foam

B - Espanso densità portante /
Foam supporting density

F - Fibra siliconata /
Silicone polyester fibre

L - Fusto in legno /
Wooden frame

M - Espanso densità media /
Foam medium density

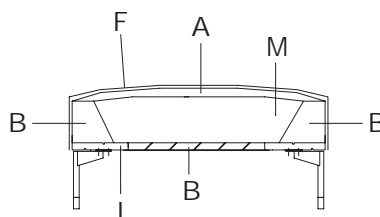

120-Modern_Air design Gianluigi Landoni

M ³	Kg.	MI.	M ²			 <i>Possibile su misura</i> <i>Special sizes available</i>	Tessuto - Fabric					Pelle - Leather		
Volume	Peso	Tessuto	Pelle	Imballi legno	Prelavaggio p. 7/10		<input type="radio"/> previsto (rif. tab. pag. 3) / available: s.table p.3 <input type="radio"/> incluso / included	Tessuto cliente	D - F - Aqua	Extra	Super	Nature	Pelle cliente	Pelle
Volume	Weight	Fabric	Leather	Wood packaging	Prewash p. 7/10		COM					COL		

0,3	9	3	4,5	'	+10%	120009	120010	801	824	891	979	1.009	1.188	1.320	1.586	
						Rivestimento / Replacement cover		361	397	464	551	581				

0,7	22	7	10	'	+10%	120001		2.397	2.456	2.625	2.886	2.971	3.114	3.461	4.153	
						Rivestimento / Replacement cover		959	1.060	1.227	1.489	1.575				

0,8	23,5	8,5	12	'	+10%	120002		2.563	2.577	2.759	3.035	3.125	3.276	3.640	4.405	
						Rivestimento / Replacement cover		1.026	1.084	1.264	1.540	1.631				

0,9	26	10,5	14	'	+10%	120003		2.896	2.913	3.117	3.429	3.532	3.702	4.113	4.976	
						Rivestimento / Replacement cover		1.159	1.225	1.428	1.740	1.844				

0,7	20	7	10	'	+10%	120004	120005	2.480	2.494	2.670	2.934	3.024	3.170	3.522	4.261	
						Rivestimento / Replacement cover		993	1.049	1.224	1.489	1.578				

0,8	23	7	9	'	+10%	120006	120007	2.480	2.494	2.670	2.934	3.024	3.170	3.522	4.261	
						Rivestimento / Replacement cover		993	1.049	1.224	1.489	1.578				

0,4	13	3,5	5	'	+10%	120008		1.679	1.688	1.806	1.987	2.046	2.145	2.383	2.883	
						Rivestimento / Replacement cover		672	710	827	1.009	1.068				

I prezzi sono espressi in Euro
Prices are in Euro

Consultare condizione di vendita e avvertenze importanti
Please check our sale conditions and important remarks

M ³	Kg.			
Volume Volume	Peso Weight	Imballi legno Wood packaging		Rovere tinto, Moka o noce canaletto o laccato lucido o opaco. Moka dyed oak or Caneletto walnut wood or matt or glossy lacquering

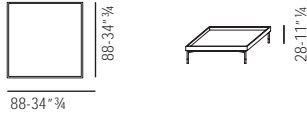

0,1	15	'	120011	1.250
-----	----	---	--------	-------

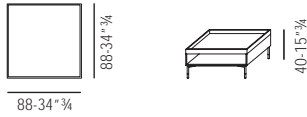

0,3	25	'	120012	1.904
-----	----	---	--------	-------

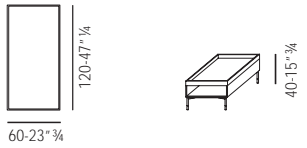

0,3	20	'	120013	1.726
-----	----	---	--------	-------

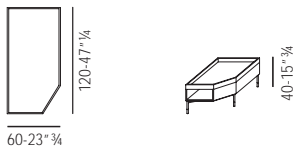

0,3	20	'	120014	1.726
-----	----	---	--------	-------

Il totale delle composizioni potrà non corrispondere a causa di arrotondamenti automatici.

The total amount in compositions may not correspond to the sum of single prices due to automatic rounding.

O.tà / Qty / Q.té / Stk	Tessuto - Fabric					Pelle - Leather		
	Tessuto cliente COM	D - F - Aqua	Extra	Super	Nature	Pelle cliente COL	Pelle	Pelle Lusso

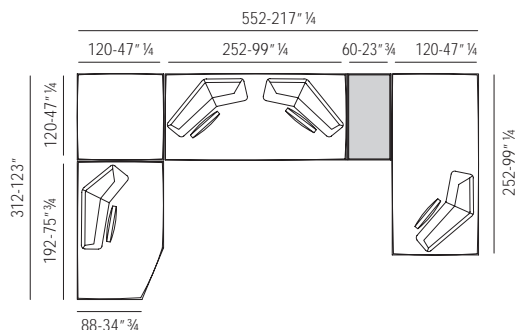

120009	4	3.199	3.295	3.560	3.912	4.031	4.750	5.277	6.344
960006	4	883	900	952	1.100	1.134	1.257	1.400	1.634
120005	1	2.480	2.494	2.670	2.934	3.024	3.170	3.522	4.261
120008	1	1.679	1.688	1.806	1.987	2.046	2.145	2.383	2.883
120003	1	2.896	2.913	3.117	3.429	3.532	3.702	4.113	4.976
120012	1	1.776	1.726	1.726	1.726	1.726	1.675	1.675	1.675
120003	1	2.896	2.913	3.117	3.429	3.532	3.702	4.113	4.976
Totale / Total		15.803	15.923	16.942	18.511	19.019	20.399	22.481	26.747

1

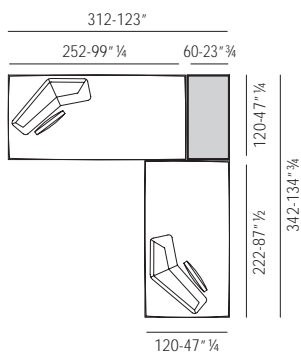

120009	2	1.600	1.648	1.780	1.957	2.016	2.375	2.639	3.172
960006	2	442	451	476	550	568	629	700	817
120003	1	2.896	2.913	3.117	3.429	3.532	3.702	4.113	4.976
120012	1	1.776	1.726	1.726	1.726	1.726	1.675	1.675	1.675
120002	1	2.563	2.577	2.759	3.035	3.125	3.276	3.640	4.405
Totale / Total		9.274	9.311	9.855	10.692	10.963	11.656	12.767	15.043

2

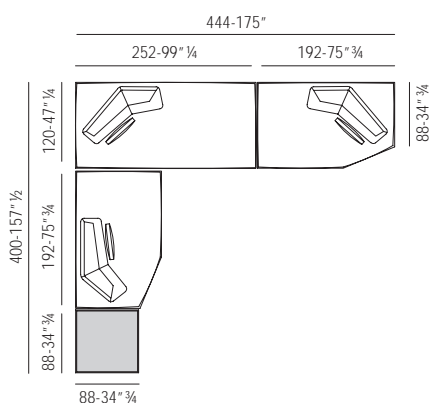

120009	3	2.399	2.471	2.671	2.934	3.024	3.563	3.958	4.758
960006	3	662	676	714	825	851	943	1.050	1.251
120011	1	1.959	1.904	1.904	1.904	1.904	1.848	1.848	1.848
120005	1	2.480	2.494	2.670	2.934	3.024	3.170	3.522	4.261
120003	1	2.896	2.913	3.117	3.429	3.532	3.702	4.113	4.976
120004	1	2.480	2.494	2.670	2.934	3.024	3.170	3.522	4.261
Totale / Total		12.873	12.948	13.740	14.958	15.354	16.393	18.012	21.354

3

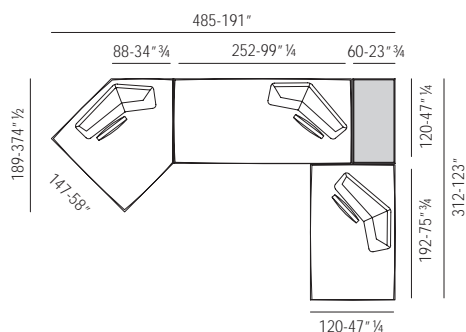

120009	3	2.399	2.471	2.671	2.934	3.024	3.563	3.958	4.758
960006	3	662	676	714	825	851	943	1.050	1.251
120006	1	2.480	2.494	2.670	2.934	3.024	3.170	3.522	4.261
120003	1	2.896	2.913	3.117	3.429	3.532	3.702	4.113	4.976
120012	1	1.776	1.726	1.726	1.726	1.726	1.675	1.675	1.675
120001	1	2.397	2.456	2.625	2.886	2.971	3.114	3.461	4.153
Totale / Total		12.606	12.732	13.516	14.730	15.123	16.165	17.777	21.072

4

I prezzi sono espressi in Euro
Prices are in Euro

Consultare condizione di vendita e avvertenze importanti
Please check our sale conditions and important remarks



Descrizione prodotto

Poltrona, divani, divani componibili, terminali, chaises longues, pouf, tavolino

Caratteristiche tecniche

Struttura: Legno multistrato

Molleggio: Nastri elastici unidirezionali ad alta portata

Imbottitura: Poliuretano espanso ricoperto con resinato accoppiato a vellutino

Cuscini seduta: Poliuretano espanso a quote differenziate e memory ricoperto in termolegato cotone 100%.

Cuscini schienale: Piuma lavata e sterilizzata con fodera a sezioni separate e con tampone interno in poliuretano espanso.

Cuscini poggiatesta: fibra poliestere siliconata ricoperta da fodera in cotone 100%

Telaio e piedi: Rovere tinto moka o noce Canaletto

Ripiani: Rovere listellare tinto moka o noce Canaletto o cuoio

Rivestimento: Rivestimento in tessuto o in pelle. Rivestimento in tessuto completamente sfoderabili.

Accessorio per ripiano in legno listellare: tavolino con piano in vetro fumé nero o marmi, gamba in metallo nero.

Accessorio: poggiatesta con struttura in metallo rivestita in cuoio (colori vedi cartella) con cuscino in fibra poliestere siliconata ricoperta da fodera cotone 100%.

Tavolino

Ripiano: rovere listellare tinto moka o noce canaletto e marmi (vedi catalogo)

Piedi: rovere tinto moka o noce Canaletto

Note particolari

All'ordine specificare tipo legno e tipo marmo o colore cuoio. Alla consegna i piedi sono smontati.

Description of the product

Armchair, sofas, unit sofas, end element, chaises longues, ottoman, small table

Technical features

Frame: Multilayer

Springing: High resistance unidirectional elastic bands.

Padding: Polyurethane foam covered with heated bonded polyester fibre.

Seat cushions: Polyurethane foam with different densities and memory covered with 100% cotton lining

Back cushions: Core in polyurethane foam covered with a feather layer in separate sections

Backrest cushions: silicone polyester fiber covered with 100% cotton lining

Frame and feet: Solid oak moka dyed or Canaletto walnut wood

Top: Moka dyed slatted oak or Canaletto walnut wood or emery leather

Cover: Fabric or leather. Fabric cover completely removable

Accessory for slatted wood top: small table with black fumé glass or marbles top and black metal legs

Accessory: Headrest with metal frame covered with emery leather (see leather folder) and cushion in silicone polyester fibre covered with 100% cotton lining.

Small table

Top: Moka dyed slatted oak or canaletto walnut wood and marbles (see catalog)

Feet: moka dyed oak or Canaletto walnut wood

Special notes

On order please specify wood and marble type or emery leather colour.

Sofas are delivered with disassembled feet.

Produktbeschreibung

Sessel, Sofas, Anbauelemente, Schlusselemente, Chaises longues, Hocker, Tischchen

Technische Angaben

Gestell: Schichtholz

Federung: mit hochbelastbaren und unidirektionalen elastischen Gurten

Polsterung: Polyurethanschaumstoff mit termisch gebundenen Fasern und samtartiger Resinatabdeckung

Sitkissen: Polyurethanschaustoff in verschiedenen Quoten u. Memory mit thermisch gebundenen Fasern mit 100% Baumwollbezug.

Rückenkissen: Polyurethanschaumstoffkern mit gewaschenen und sterilisierten Daunen in separaten Kammern bezogen

Rückenstützkissen: Silikon-Polyester-Fasern mit einem Bezug aus 100% Baumwolle

Rahmen u. Füße: mokka gebeizte Eiche o. Canaletto Walnuss

Seitliche: Ablage mit Latten in mokka gebeizter Eiche o. Canaletto Walnuss o. Kernleder

Bezug: Bezug aus Stoff oder Leder. Stoffbezug ganz abnehmbar

Zubehör für Lattenholzablage: Tischchen für Holzablage in Glas Schwarzfumé o. Marmor mit Gestell aus schwarzlackiertem Metall.

Zubehör: Kopfstütze bestehend aus Eisenrohrgestell m. Kernleder bezogen (Farben s. Ledermappe) u. Kissen in Silikon-Polyester-Fasern mit einem Bezug aus 100% Baumwolle.

Tisch

Tischplatte: mit Latten in mokka gebeizter Eiche o. Canaletto Walnuss u. Marmor (s. Katalog)

Füße: mokka gebeizte Eiche o. Canaletto Walnuss

Bemerkungen

Bei der Bestellung bitte Marmor, Holzart oder Kernlederfarbe angeben.

Bei der Lieferung sind die Füße nicht montiert.

Description du produit

Fauteuil, canapés, canapés modulable, éléments terminaux, chaises longues, pouf, petite table

Caractéristiques techniques

Structure: Multiplis

Suspension: Sangles élastiques unidirectionnelles à haute résistance

Rembourrage: Mousse de polyuréthane de différentes densités, enrobée en fibre thermomoullée.

Coussin d'assise: Mousse de polyuréthane de différentes densités et memory enrobée en fibre thermomoullée recouverte de coton 100%.

Coussin de dossier: Plume lavée et stérilisée en sections distinctes avec élément intercalaire en mousse.

Coussin appui-reins: fibre en polyester siliconé recouverte de coton 100%

Structure et pieds: chêne teinté moka ou en noyer Canaletto

Étagères: chêne lamellé teinté moka ou noyer Canaletto ou cuir sellier

Revêtement: Revêtement en tissu ou en cuir. Revêtement en tissu entièrement déhoussable

Accessoire pour étagère en bois lamellé: petite table avec plateau en verre fumé noir ou marbres, pied en métal noir.

Accessoire: Appuie-tête avec structure en métal recouverte de cuir sellier (voir couleurs) et coussin en fibre en polyester siliconé recouverte de coton 100%.

Table

Plateau: chêne teinté moka ou noyer canaletto et marbres (voir catalogue)

Pieds: chêne teinté moka ou noyer Canaletto

Remarques

A la commande spécifier le type de marbre, le type de bois ou la couleur de cuir sellier.

A la livraison les pieds sont démontés.

- A - Memory foam / Memory foam
- B - Espanso densità portante / Foam supporting density
- C - Espanso densità soft / Foam soft density
- L - Fusto in legno / Wooden frame
- P - Piuma / feather
- S - Fibra poliestere siliconata / Silicone polyester fibre

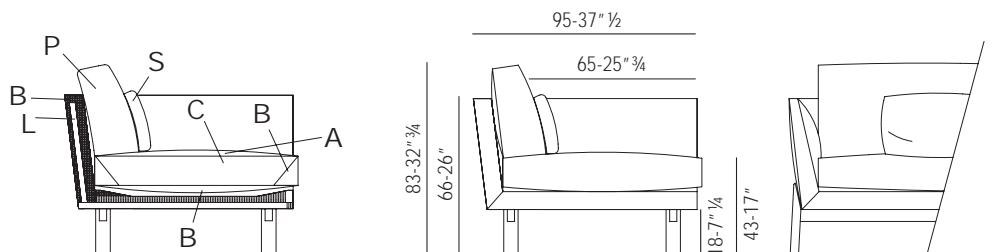

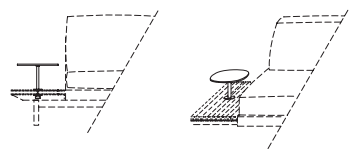

(*) Accessorio per ripiano legno lamellare / Accessory for slatted wood top

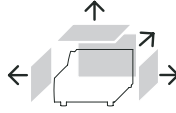
 <p>150048</p>		Vetro Fumé nero Black Fumé glass	Bianco carrara Carrara white	Calacatta Calacatta	Marquinia nero Marquinia black	Emperador Emperador	Travertino Travertino	Sahara noir Sahara noir	
		590	846	941	876	876	933	941	

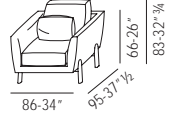
M ³	Kg.	MI.	M ²			Tessuto - Fabric					Pelle - Leather			
Volume Volume	Peso Weight	Tessuto Fabric	Pelle Leather	Imballi legno Wood packaging	Prelavaggio p. 7/10 Prewash p. 7/10	 <p>Possibile su misura Special sizes available</p>	Tessuto cliente COMI	D - F - Aqua	Extra	Super	Nature	Pelle cliente COL	Pelle	Pelle Lusso
							<input type="radio"/> previsto (rif. tab. pag. 3) / available: s.table p.3 <input type="radio"/> incluso / included							

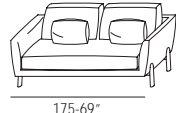
 <p>150001</p>							3.137	3.201	3.393	3.623	3.731	4.112	4.565	5.479
0,50	20	9,8	12,8	'	+10%	Rivestimento / Replacement cover	1.276	1.392	1.583	1.813	1.920			

 <p>150002</p>							4.086	4.169	4.418	4.723	4.864	5.377	5.970	7.164
1,02	40	13,6	17,2	'	+10%	Rivestimento / Replacement cover	1.673	1.824	2.075	2.379	2.518			

 <p>150003</p>							4.290	4.377	4.639	4.959	5.107	5.644	6.265	7.518
1,19	47	14,6	18,6	'	+10%	Rivestimento / Replacement cover	1.755	1.914	2.177	2.495	2.642			

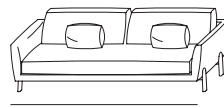
 <p>150004</p>							4.495	4.586	4.861	5.193	5.349	5.909	6.559	7.871
1,37	54	16,6	23,1	'	+10%	Rivestimento / Replacement cover	1.837	2.004	2.279	2.612	2.766			

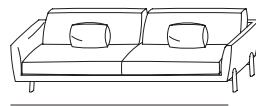
 <p>150044</p>							4.944	5.044	5.347	5.714	5.885	6.501	7.215	8.657
1,89	61	18	27	'	+10%	Rivestimento / Replacement cover	2.021	2.204	2.508	2.874	3.042			

I prezzi sono espressi in Euro
Prices are in Euro

Consultare condizione di vendita e avvertenze importanti
Please check our sale conditions and important remarks

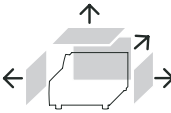
M ³	Kg.	MI.	M ²			Tessuto - Fabric					Pelle - Leather			
Volume Volume	Peso Weight	Tessuto Fabric	Pelle Leather	Imballi legno Wood packaging	Prelavaggio p. 7/10 Prewash p. 7/10	 <i>Possibile su misura</i> <i>Special sizes available</i>	Tessuto cliente COM	D - F - Aqua	Extra	Super	Nature	Pelle cliente COL	Pelle	Pelle Lusso
							<input type="radio"/> previsto (rif. tab. pag. 3) / available: s.table p.3 <input type="radio"/> incluso / included							

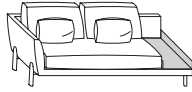
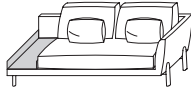
						 190-75"	 190-75"								
1,13	54,6	12,6	16,1	'	+10%	150006	150005	4.741	4.778	4.969	5.243	5.369	5.740	6.293	7.351
							Rivestimento / Replacement cover	1.673	1.824	2.075	2.379	2.518			

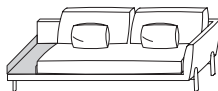
						 220-86*¾	 220-86*¾								
1,31	61,5	13,6	19,4	'	+10%	150008	150007	4.945	4.985	5.190	5.479	5.611	6.006	6.589	7.706
							Rivestimento / Replacement cover	1.755	1.914	2.177	2.495	2.642			

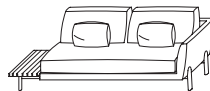
						 200-78*¾	 200-78*¾								
1,13	56,6	11,6	15,3	'	+10%	150010	150009	5.145	5.170	5.362	5.636	5.762	6.121	6.674	7.732
							Rivestimento / Replacement cover	1.509	1.638	1.830	2.104	2.227			

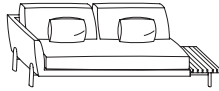
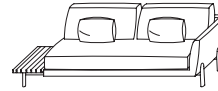
						 230-90*¾	 230-90*¾								
1,35	63,5	13,6	17,1	'	+10%	150012	150011	5.349	5.378	5.583	5.871	6.004	6.388	6.970	8.087
							Rivestimento / Replacement cover	1.591	1.727	1.932	2.219	2.351			

						 120-47*¾									
0,73	29	9,6	12	'	+10%	150013		2.546	2.598	2.754	2.950	3.039	3.374	3.745	4.495
							Rivestimento / Replacement cover	1.057	1.152	1.307	1.503	1.591			

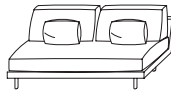
						 180-71"									
1,02	40	12,6	15,9	'	+10%	150014		3.469	3.524	3.671	3.929	4.045	4.359	4.902	5.883
							Rivestimento / Replacement cover	1.427	1.540	1.687	1.943	2.059			

I prezzi sono espressi in Euro
Prices are in Euro

Consultare condizione di vendita e avvertenze importanti
Please check our sale conditions and important remarks

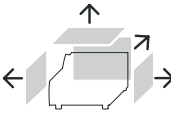
M ³	Kg.	MI.	M ²			Tessuto - Fabric					Pelle - Leather			
Volume Volume	Peso Weight	Tessuto Fabric	Pelle Leather	Imballi legno Wood packaging	Prelavaggio p. 7/10 Prewash p. 7/10	 <i>Possibile su misura</i> <i>Special sizes available</i>	Tessuto cliente COM	D - F - Aqua	Extra	Super	Nature	Pelle cliente COL	Pelle	Pelle Lusso
							<input type="radio"/> previsto (rif. tab. pag. 3) / available: s.table p.3 <input type="radio"/> incluso / included							

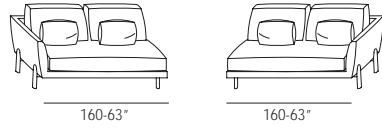

0,96	37,7	11,6	15,3	'	+10%	150016	150015	3.676	3.743	3.934	4.208	4.334	4.735	5.288	6.346
							Rivestimento / Replacement cover	1.509	1.638	1.830	2.104	2.227			

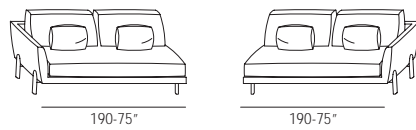

1,15	44,5	13,6	17,1	'	+10%	150018	150017	3.880	3.951	4.155	4.444	4.577	5.002	5.584	6.701
							Rivestimento / Replacement cover	1.591	1.727	1.932	2.219	2.354			

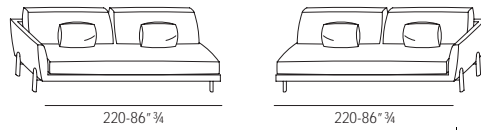

1,31	51,5	15,6	19,8	'	+10%	150020	150019	4.085	4.160	4.377	4.559	4.819	5.267	5.877	7.053
							Rivestimento / Replacement cover	1.673	1.821	2.034	2.336	2.475			

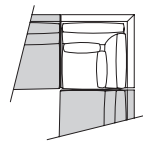

0,60	23,3	11,6	16,2	'	+10%	150021		2.977	3.038	3.221	3.447	3.551	3.936	4.369	5.243
							Rivestimento / Replacement cover	1.231	1.340	1.523	1.750	1.851			

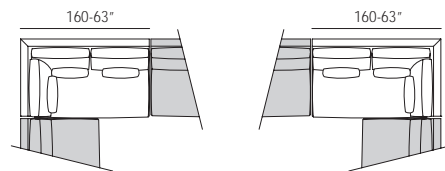

0,96	38	15,9	21,4	'	+10%	150023	150022	4.294	4.380	4.644	4.972	5.121	5.678	6.303	7.565
							Rivestimento / Replacement cover	1.776	1.934	2.197	2.525	2.671			

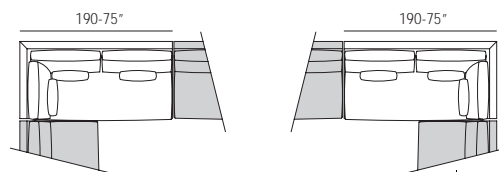

1,15	46	17,4	24,4	'	+10%	150025	150024	4.528	4.620	4.898	5.243	5.400	5.985	6.643	7.980
							Rivestimento / Replacement cover	1.869	2.038	2.315	2.660	2.813			

I prezzi sono espressi in Euro
Prices are in Euro

Consultare condizione di vendita e avvertenze importanti
Please check our sale conditions and important remarks

M ³	Kg.	MI.	M ²			Tessuto - Fabric					Pelle - Leather		
Volume Volume	Peso Weight	Tessuto Fabric	Pelle Leather	Imballi legno Wood packaging	Prelavaggio p. 7/10 Prewash p. 7/10	Tessuto cliente COM	D - F - Aqua	Extra	Super	Nature	Pelle cliente COL	Pelle	Pelle Lusso

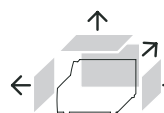

○ previsto (rif. tab. pag. 3) / available: s.table p.3
incluso / included

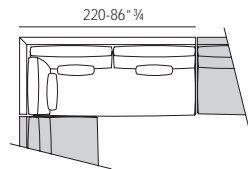

150027

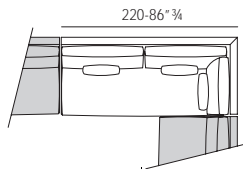

150026

1,31	53	19,9	27,4	'	+10%									
						Rivestimento / Replacement cover	4.765	4.861	5.153	5.633	5.762	6.291	6.984	8.381
							1.965	1.783	2.433	2.793	3.040			

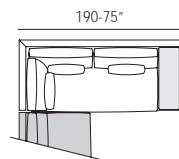

150029

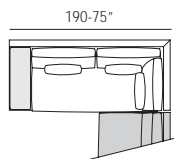

150028

1,15	54,6	15,9	21,4	'	+10%									
						Rivestimento / Replacement cover	5.359	5.415	5.678	6.006	6.155	6.683	7.308	8.569
							1.776	1.934	2.197	2.525	2.671			

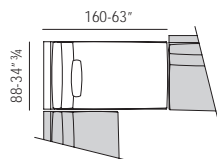

150030

0,96	37,7	8,8	12,3	'	+10%									
						Rivestimento / Replacement cover	2.761	2.818	2.985	3.188	3.283	3.623	4.021	4.825
							1.125	1.227	1.396	1.599	1.693			

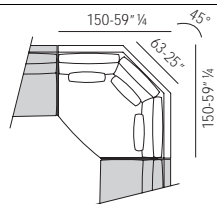

150031

1,28	50,5	16,9	22,4	'	+10%									
						Rivestimento / Replacement cover	5.764	5.879	6.234	6.666	6.866	7.592	8.427	10.115
							2.364	2.576	2.931	3.363	3.557			

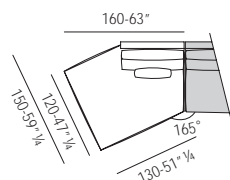

150033

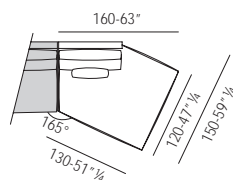

150032

1,16	45,7	10,8	15,4	'	+10%									
						Rivestimento / Replacement cover	4.154	4.237	4.492	4.793	4.937	5.436	6.034	7.241
							1.682	1.836	2.090	2.391	2.533			

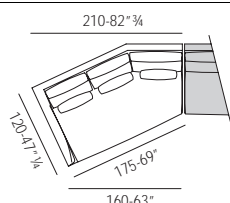

150035

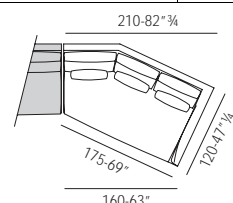

150034

1,61	63,5	15,4	19,4	'	+10%									
						Rivestimento / Replacement cover	5.267	5.374	5.696	6.092	6.276	6.944	7.709	9.251
							2.166	2.360	2.682	3.079	3.259			

I prezzi sono espressi in Euro
Prices are in Euro

Consultare condizione di vendita e avvertenze importanti
Please check our sale conditions and important remarks

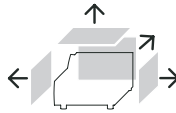
M ³	Kg.	MI.	M ²			Tessuto - Fabric					Pelle - Leather			
Volume Volume	Peso Weight	Tessuto Fabric	Pelle Leather	Imballi legno Wood packaging	Prelavaggio p. 7/10 Prewash p. 7/10	 <p>Possibile su misura Special sizes available</p>	Tessuto cliente COM	D - F - Aqua	Extra	Super	Nature	Pelle cliente COL	Pelle	Pelle Lusso
					<input type="radio"/> previsto (rif. tab. pag. 3) / available: s.table p.3 <input type="radio"/> incluso / included									

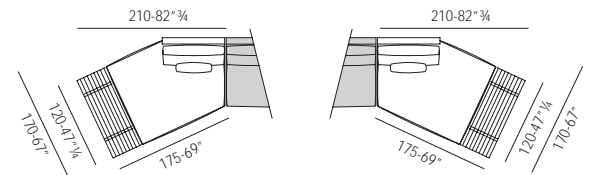

						150037	150036								
1,36	68,6	10,8	15,4	'	+10%			5.745	5.784	6.039	6.339	6.484	6.937	7.536	8.743
							Rivestimento / Replacement cover	1.682	1.836	2.090	2.391	2.533			

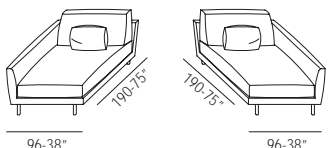

						150039	150038								
1,15	40	11,3	15,3	'	+10%			3.929	4.008	4.249	4.534	4.669	5.143	5.709	6.850
							Rivestimento / Replacement cover	1.591	1.736	1.977	2.263	2.397			

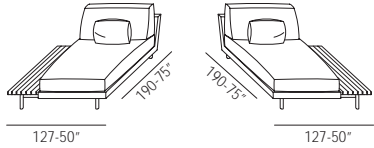

						150041	150040								
1,18	65,6	9,8	13,3	'	+10%			4.474	4.520	4.739	5.000	5.124	5.532	6.047	7.089
							Rivestimento / Replacement cover	1.515	1.653	1.882	2.153	2.282			

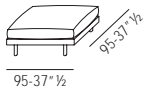

						150042									
0,59	23	3,5	7	'	+10%			1.591	1.623	1.721	1.833	1.888	2.070	2.298	2.757
							Rivestimento / Replacement cover	638	697	795	906	961			



						150043									
0,02	5	1,5	2	'	+10%			703	697	711	733	744	736	756	840
							Rivestimento / Replacement cover	214	215	221	231	238			

Il totale delle composizioni potrà non corrispondere a causa di arrotondamenti automatici.

The total amount in compositions may not correspond to the sum of single prices due to automatic rounding.

Q.tà / Qty / Q.té / Stk	Tessuto - Fabric					Pelle - Leather		
	Tessuto cliente COM	D - F - Aqua	Extra	Super	Nature	Pelle cliente COL	Pelle	Pelle Lusso

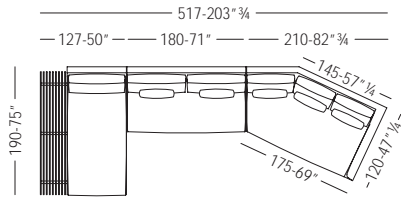

1

150041	1	4.474	4.520	4.739	5.000	5.124	5.532	6.047	7.089
150014	1	3.469	3.524	3.671	3.929	4.045	4.359	4.902	5.883
150034	1	5.267	5.374	5.696	6.092	6.276	6.944	7.709	9.251
150048	1	607	590	590	590	590	572	572	572
Totale / Total		13.813	14.006	14.693	15.607	16.032	17.406	19.229	22.793

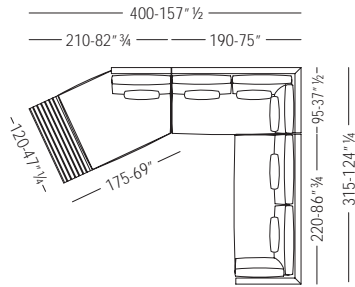

2

150037	1	5.745	5.784	6.039	6.339	6.484	6.937	7.536	8.743
150024	1	4.528	4.620	4.898	5.243	5.400	5.985	6.643	7.980
150019	1	4.085	4.160	4.377	4.559	4.819	5.267	5.877	7.053
150048	1	607	590	590	590	590	572	572	572
Totale / Total		14.962	15.152	15.899	16.728	17.289	18.760	20.626	24.347

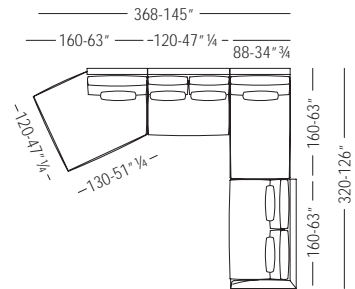

3

150033	1	4.154	4.237	4.492	4.793	4.937	5.435	6.034	7.241
150013	1	2.546	2.598	2.754	2.950	3.039	3.374	3.745	4.495
150015	1	3.676	3.743	3.934	4.208	4.334	4.735	5.288	6.346
Totale / Total		10.374	10.576	11.177	11.949	12.308	13.544	15.066	18.081

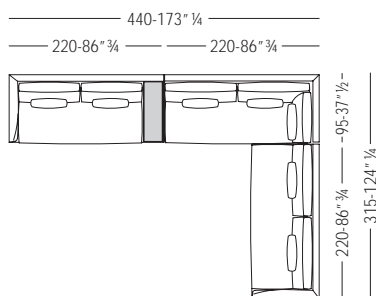

4

150008	1	4.945	4.985	5.190	5.479	5.611	6.006	6.589	7.706
150026	1	4.765	4.861	5.153	5.633	5.762	6.291	6.984	8.381
150019	1	4.085	4.160	4.377	4.559	4.819	5.267	5.877	7.053
Totale / Total		13.791	14.005	14.719	15.669	16.190	18.603	19.448	23.139

I prezzi sono espressi in Euro
Prices are in Euro

Consultare condizione di vendita e avvertenze importanti
Please check our sale conditions and important remarks

**Descrizione prodotto**

Divani, divani componibili, terminali, chaises longues, pouf

Caratteristiche tecniche

Struttura: Legno multistrato

Molleggio: Nastri elastici unidirezionali ad alta portata

Imbottitura: Poliuretano espanso ricoperto con resinato accoppiato a vellutino

Cuscini seduta: Poliuretano espanso a quote differenziate e memory, ricoperto in termolegato cotone 100%

Cuscini schienale: Piuma lavata e sterilizzata

Piedi: metallo verniciato nero

Rivestimento: Rivestimento in tessuto o in pelle. Rivestimento in tessuto completamente sfoderabili.

Note particolari

Alla consegna i piedi sono smontati.

Description of the product

Sofas, unit sofas, end element, chaises longues, ottoman

Technical features

Frame: Multilayer

Springing: High resistance unidirectional elastic bands.

Padding: Polyurethane foam covered with heated bonded polyester fibre

Seat cushions: in polyurethane foam with different densities and memory covered with 100% cotton lining.

Back cushions: Washed and sterilized feathers

Feet: Dyed black metal

Cover: Fabric or leather. Fabric cover completely removable

Special notes

Sofas are delivered with disassembled feet.

Produktbeschreibung

Sofas, Anbauelemente, Schlusselemente, Chaises longues, Hocker

Technische Angaben

Gestell: Schichtholz

Federung: mit hochbelastbaren und unidirektionalen elastischen Gurten

Polsterung: Polyurethanschaumstoff mit termisch gebundenen Fasern und samtartiger Resinatabdeckung

Sitkissen: Polyurethanschaumstoff in verschiedenen Quoten u. Memory mit thermisch gebundenen Fasern mit 100% Baumwollbezug.

Rückenkissen: gewaschene und sterilisierte Daune.

FüÙe: Schwarzlackiertes Metall

Bezug: Bezug aus Stoff oder Leder. Stoffbezug ganz abnehmbar

Bemerkungen

Bei der Lieferung sind die FüÙe nicht montiert.

Description du produit

Canapés, canapés modulable, éléments terminaux, chaises longues, pouf

Caractéristiques techniques

Structure: Multiplis

Suspension: Sangles élastiques unidirectionnelles à haute resistance

Rembourrage: Mousse de polyuréthane de différentes densités, enrobée en fibre thermomoullée.

Coussin d'assise: Mousse de polyuréthane de différentes densités et memory enrobée en fibre thermomoullée recouverte de coton 100%

Coussin de dossier: en plume lavée et stérilisée.

Pieds: Métal teinté en noir

Revêtement: Revêtement en tissu ou en cuir. Revêtement en tissu entièrement déhoussable

Remarques

A la livraison les pieds sont démontés.

- A - Memory foam / Memory foam
- B - Espanso densità portante / Foam supporting density
- C - Espanso densità soft / Foam soft density
- L - Fusto in legno / Wooden frame
- P - Piuma / feather

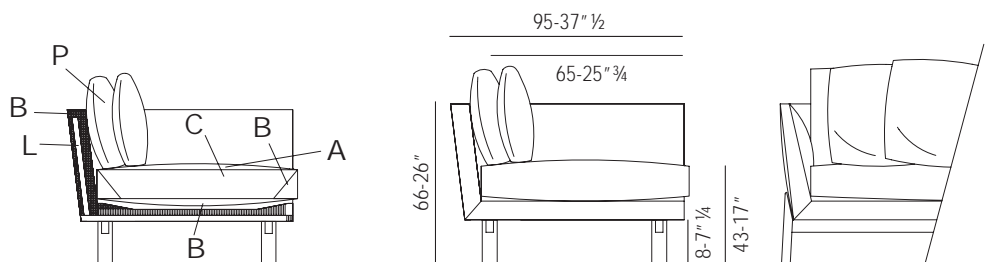

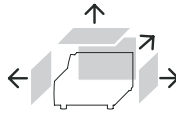
M ³	Kg.	MI.	M ²			Tessuto - Fabric					Pelle - Leather			
Volume Volume	Peso Weight	Tessuto Fabric	Pelle Leather	Imballi legno Wood packaging	Prelavaggio p. 7/10 Prewash p. 7/10	 <i>Possibile su misura</i> <i>Special sizes available</i>	Tessuto cliente COM	D - F - Aqua	Extra	Super	Nature	Pelle cliente COL	Pelle	Pelle Lusso
							<input type="radio"/> previsto (rif. tab. pag. 3) / available: s.table p.3 <input type="radio"/> incluso / included							

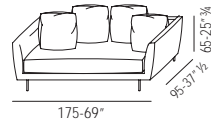

1,02	40	14	18,2	'	+10%	160001	4.283	4.371	4.632	4.934	5.081	5.575	6.188	7.425
						Rivestimento / Replacement cover	1.928	2.082	2.344	2.644	2.792			

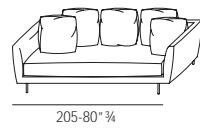

1,19	47	15	20,7	'	+10%	160002	4.508	4.599	4.876	5.192	5.348	5.868	6.514	7.815
						Rivestimento / Replacement cover	2.030	2.190	2.468	2.784	2.940			

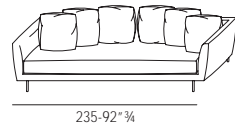

1,37	54	18	24	'	+10%	160003	4.733	4.830	5.119	5.452	5.615	6.160	6.836	8.203
						Rivestimento / Replacement cover	2.130	2.300	2.590	2.923	3.086			

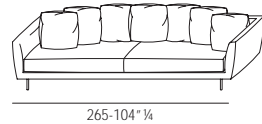

1,89	61	19,5	29	'	+10%	160023	5.207	5.312	5.630	5.997	6.176	6.776	7.520	9.023
						Rivestimento / Replacement cover	2.343	2.530	2.849	3.216	3.394			

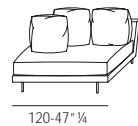

0,73	29	8,5	12,7	'	+10%	160004	2.590	2.643	2.801	2.984	3.074	3.371	3.740	4.489
						Rivestimento / Replacement cover	1.167	1.259	1.418	1.600	1.690			

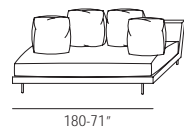

1,02	41,8	12	17	'	+10%	160005	3.606	3.663	3.811	4.059	4.180	4.455	5.013	6.017
						Rivestimento / Replacement cover	1.623	1.735	1.883	2.131	2.253			

M ³	Kg.	MI.	M ²			Tessuto - Fabric					Pelle - Leather		
Volume Volume	Peso Weight	Tessuto Fabric	Pelle Leather	Imballi legno Wood packaging	Prelavaggio p. 7/10 Prewash p. 7/10	Tessuto cliente COM	D - F - Aqua	Extra	Super	Nature	Pelle cliente COL	Pelle	Pelle Lusso



160-63*

160007



160-63*

160006

0,96	37,7	12	15,6	'	+10%		3.833	3.902	4.100	4.368	4.498	4.868	5.438	6.526
						Rivestimento / Replacement cover	1.726	1.854	2.052	2.320	2.450			

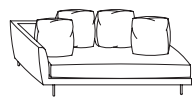

190-75*

160009

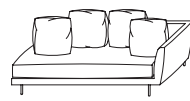

190-75*

160008

1,15	44,5	13	17,5	'	+10%		4.057	4.132	4.343	4.625	4.765	5.161	5.764	6.915
						Rivestimento / Replacement cover	1.827	1.964	2.175	2.457	2.597			

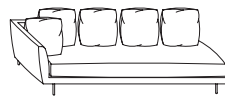

220-86*¾

160011

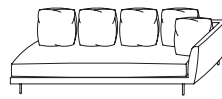

220-86*¾

160010

1,31	51,5	14	19,1	'	+10%		4.282	4.361	4.586	4.885	5.031	5.453	6.086	7.304
						Rivestimento / Replacement cover	1.928	2.071	2.295	2.595	2.741			

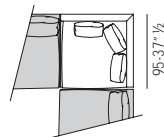

160012

0,60	23,3	12	16	'	+10%		3.066	3.127	3.314	3.531	3.636	3.989	4.426	5.312
						Rivestimento / Replacement cover	1.380	1.489	1.676	1.892	1.999			

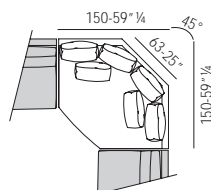

160013

1,28	50,5	17	22,5	'	+10%		6.025	6.144	6.516	6.939	7.148	7.841	8.702	10.444
						Rivestimento / Replacement cover	2.711	2.925	3.297	3.720	3.929			

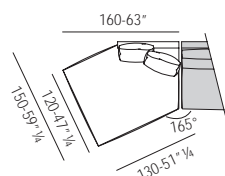

160015

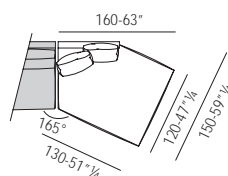

160014

1,16	45,7	10,5	15	'	+10%		4.383	4.470	4.739	5.048	5.200	5.704	6.331	7.597
						Rivestimento / Replacement cover	1.973	2.129	2.398	2.707	2.859			

I prezzi sono espressi in Euro
Prices are in Euro

Consultare condizione di vendita e avvertenze importanti
Please check our sale conditions and important remarks

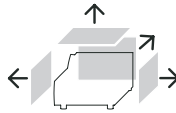
M ³	Kg.	MI.	M ²			Tessuto - Fabric					Pelle - Leather			
Volume Volume	Peso Weight	Tessuto Fabric	Pelle Leather	Imballi legno Wood packaging	Prelavaggio p. 7/10 Prewash p. 7/10	 <p>Possibile su misura Special sizes available</p>	Tessuto cliente COM	D - F - Aqua	Extra	Super	Nature	Pelle cliente COL	Pelle	Pelle Lusso
					<input type="radio"/> previsto (rif. tab. pag. 3) / available: s.table p.3 <input type="radio"/> incluso / included									

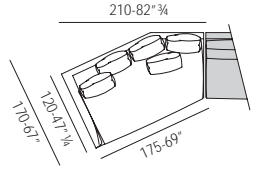
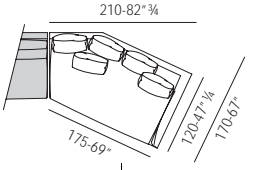
						 <p>160017</p>	 <p>160016</p>								
1,61	63,5	16	19,2	'	+10%										
						Rivestimento / Replacement cover	5.479	5.588	5.924	6.309	6.499	7.128	7.912	9.493	
							2.465	2.662	2.986	3.381	3.572				

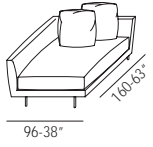
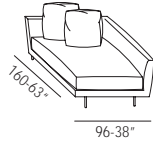
						 <p>160019</p>	 <p>160018</p>								
0,96	37,7	12	15,5	'	+10%										
						Rivestimento / Replacement cover	3.658	3.732	3.955	4.214	4.340	4.760	5.283	6.340	
							1.646	1.777	2.001	2.259	2.386				

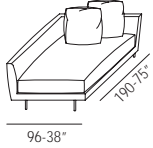
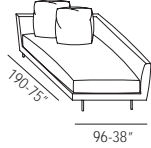
						 <p>160021</p>	 <p>160020</p>								
1,18	45,7	13	17,3	'	+10%										
						Rivestimento / Replacement cover	4.026	4.105	4.351	4.636	4.774	5.237	5.814	6.976	
							1.812	1.955	2.201	2.485	2.624				

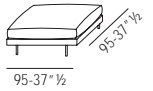
						 <p>160022</p>									
0,59	23	3,5	7	'	+10%										
						Rivestimento / Replacement cover	1.591	1.623	1.721	1.833	1.888	2.070	2.298	2.757	
							638	697	795	906	961				

Il totale delle composizioni potrà non corrispondere a causa di arrotondamenti automatici.

The total amount in compositions may not correspond to the sum of single prices due to automatic rounding.

Q.tà / Qty / Q.té / Stk	Tessuto - Fabric					Pelle - Leather		
	Tessuto cliente COM	D - F - Aqua	Extra	Super	Nature	Pelle cliente COL	Pelle	Pelle Lusso

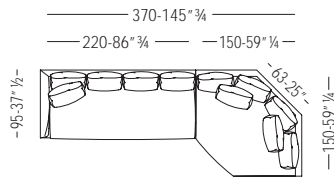

1

160011	1	4.282	4.361	4.586	4.885	5.031	5.453	6.086	7.304
160013	1	6.025	6.144	6.516	6.939	7.148	7.841	8.702	10.444
Totale / Total		10.307	10.504	11.100	11.823	12.178	13.293	14.788	17.747

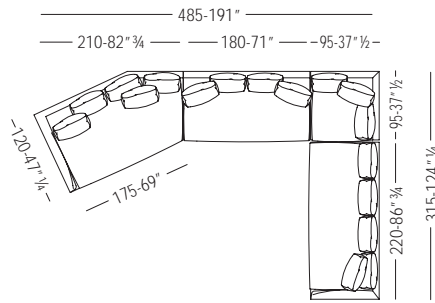

2

160017	1	5.479	5.588	5.924	6.309	6.499	7.128	7.912	9.493
160005	1	3.606	3.663	3.811	4.059	4.180	4.455	5.013	6.017
160012	1	3.066	3.127	3.314	3.531	3.636	3.989	4.426	5.312
160010	1	4.282	4.361	4.586	4.885	5.031	5.453	6.086	7.304
Totale / Total		16.430	16.738	17.632	18.780	19.343	21.024	23.437	28.125

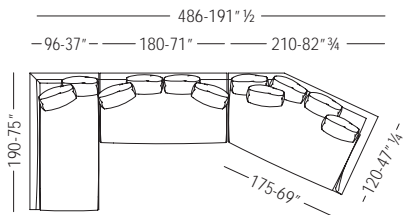

3

160021	1	4.026	4.105	4.351	4.636	4.774	5.237	5.814	6.976
160005	1	3.606	3.663	3.811	4.059	4.180	4.455	5.013	6.017
160016	1	5.479	5.588	5.924	6.309	6.499	7.128	7.912	9.493
Totale / Total		13.109	13.355	14.085	15.002	15.451	16.820	18.738	22.485

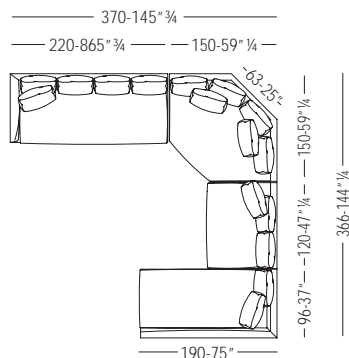

4

160011	1	4.282	4.361	4.586	4.938	5.031	5.453	6.086	7.304
160013	1	6.025	6.144	6.516	6.939	7.148	7.841	8.702	10.444
160004	1	2.590	2.643	2.801	2.984	3.074	3.371	3.740	4.489
160020	1	4.026	4.105	4.351	4.636	4.774	5.237	5.814	6.976
Totale / Total		16.920	17.250	18.252	19.493	20.022	21.900	24.341	29.210

I prezzi sono espressi in Euro
Prices are in Euro

Consultare condizione di vendita e avvertenze importanti
Please check our sale conditions and important remarks

**Descrizione prodotto**

Poltrone, divani, chaise longue, pouf, cuscino schienale pouf, tavolino

Caratteristiche tecniche

Struttura: massello di abete e legno multistrato.

Molle: nastri elastici unidirezionali ad alta portata.

Imbottitura seduta e schienale: poliuretano espanso a quota differenziate e memory foam ricoperto in termolegato cotone 100%.

Cuscino schienale pouf: poliuretano espanso di differenti densità e base interna con lastre in metallo.

Piedi: tecnici neri.

Rivestimento: in tessuto o in pelle. Rivestimento in tessuto completamente sfoderabile.

Opzione

Cuscini schienale: in fibra poliestere siliconata ricoperta da fodera in cotone 100%.

Tavolino: in legno laccato. RAL colori: 9011 - 9003 - 7015 - 7044 - 7006

Note particolari

I cuscini schienale non sono compresi nel costo dei divani.

Nelle composizioni è necessario il disegno.

Description of the product

Armchairs, sofas, chaise longue, ottoman, ottoman back cushion, small table

Technical features

Frame: solid fir-wood and multilayer.

Springing: high resistance unidirectional elastic bands.

Seat and backrest padding: polyurethane foam with different densities and memory foam covered with heated bonded with 100% cotton lining.

Ottoman back cushion: polyurethane foam with different densities inner base with metal slab.

Feet: black standard.

Cover: fabric or leather cover. Fabric cover completely removable.

Option

Back cushions: silicone polyester fibre covered with 100% cotton lining.

Small table: lacquered wood.

(colours RAL: 9011 - 9003 - 7015 - 7044 - 7006)

Special notes

Back cushions are not included in the sofas price.

For compositions, please, supply the drawing.

Produktbeschreibung

Sessel, Sofas, Chaise longue, Hocker, Rückenkissen f. Hocker, Tischchen

Technische Angaben

Gestell: aus massivem Fichtenholz un Schichtholz.

Federung: mit hochbelastbaren und unidirektionalen elastischen Gurten.

Sitz- und Rückenlehnpolsterung: Polyurethanschäumstoff in verschiedenen Quoten und Memory mit thermisch gebundenen Fasern mit 100% Baumwollschicht.

Rückenkissen f. Hocker: Polyurethanschäumstoff in verschiedenen Quoten mit innere Metalplatte.

Füße: Standard schwarz.

Bezug: Bezug aus Stoff oder Leder. Stoffbezug ganz abnehmbar.

Option

Rückenkissen: Silikon-Polyester-Fasern mit einem Bezug aus 100% Baumwolle.

Tischchen: Lackiertes Holztischchen.

(farben RAL: 9011 - 9003 - 7015 - 7044 - 7006)

Bemerkungen

Die Rückenkissen sind extra zu bestellen.

Im Falle von Kombinationen bitte Skizze.

Description du produit

Fauteuils, canapés, chaise longue, pouf, coussin dossier pour pouf, petite table

Caractéristiques techniques

Structure: sapin massif et multiplis.

Suspension: sangles élastiques unidirectionnelles à haute résistance.

Rembourrage assise et dossier: mousse de polyurethane de différentes densités et memory enrobée en fibre thermomoulée recouverte de coton 100%.

Coussin dossier pouf: mousse de polyurethane de différentes densités avec plateau en métal à l'intérieur

Pieds: standard noir.

Revêtement: en tissu ou en cuir. Revêtement en tissu entièrement déhoussable.

Option

Coussins dossier: fibre en polyester siliconé recouverte de coton 100%.

Petite table: en bois laqué.

(coloris RAL: 9011 - 9003 - 7015 - 7044 - 7006)

Remarques:

Les coussins de dossier ne sont pas inclus dans le prix du canapé.

Pour les compositions un dessin est indispensable.

- A - Memory foam / Memory foam
- B - Espanso densità portante / Foam supporting density
- C - Espanso densità soft / Foam soft density
- L - Fusto in legno / Wooden frame
- R - Resinato / Heated bonded polyester fibre

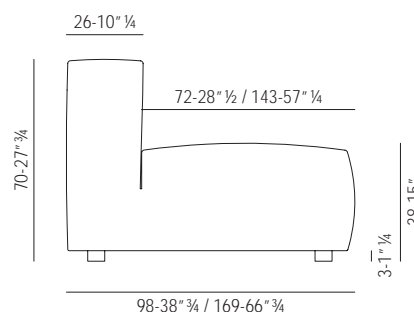
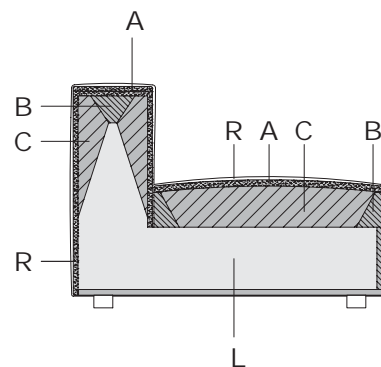

M ³	Kg.	MI.	M ²				Tessuto - Fabric					Pelle - Leather		
Volume Volume	Peso Weight	Tessuto Fabric	Pelle Leather	Imballi legno Wood packaging	Prelavaggio p. 7/10 Prewash p. 7/10		<input type="radio"/> previsto (rif. tab. pag. 3) / available: s.table p.3 <input type="radio"/> incluso / included	Tessuto cliente COM	D - F - Aqua	Extra	Super	Nature	Pelle cliente COL	Pelle

							200021											
0,04	4	1	1,4		+10%													
							Rivestimento / Replacement cover	352	367	391	438	451	516	572	717			
								221	237	264	310	320	405	450	593			

							200020											
					+10%													
							Rivestimento / Replacement cover	177	182	192	197	205	251	279	334			
								123	130	140	145	152	200	228	283			

							200001											
					+10%													
							Rivestimento / Replacement cover	251	255	271	311	320	359	399	480			
								158	166	181	221	230	271	312	392			

							200015											
0,12	12	1,5	1,7		+10%													
							Rivestimento / Replacement cover	514	513	526	558	576	648	720	814			
								222	229	244	274	283	374	444	538			

							200002											
0,19	14	2,5	3,5		+10%													
							Rivestimento / Replacement cover	435	456	495	553	571	697	774	961			
								180	208	247	305	315						

							200003											
0,25	14	2,5	3,6		+10%													
							Rivestimento / Replacement cover	513	535	580	651	670	822	914	1.131			
								212	249	290	360	370						

							200004											
0,21	13	2,5	3,6		+10%													
							Rivestimento / Replacement cover	523	548	593	666	685	836	928	1.144			
								216	256	297	371	382						

I prezzi sono espressi in Euro
Prices are in Euro

Consultare condizione di vendita e avvertenze importanti
Please check our sale conditions and important remarks

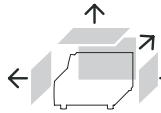
M ³	Kg.	MI.	M ²			 Possibile su misura Special sizes available	Tessuto - Fabric					Pelle - Leather		
Volume Volume	Peso Weight	Tessuto Fabric	Pelle Leather	Imballi legno Wood packaging	Prelavaggio p. 7/10 Prewash p. 7/10		<input type="radio"/> previsto (rif. tab. pag. 3) / available: s.table p.3 <input type="radio"/> incluso / included	Tessuto cliente COM	D - F - Aqua	Extra	Super	Nature	Pelle cliente COL	Pelle

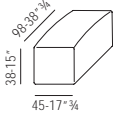
						200005		495	520	561	640	659	795	883	1.087
0,19	12	2,5	3,6	'	+10%	Rivestimento / Replacement cover	207	242	282	360	370				

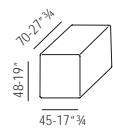
						200006		458	476	518	588	606	730	811	1.000
0,18	10	2,5	3,6	'	+10%	Rivestimento / Replacement cover	191	221	259	332	342				

						200007		1.421	1.474	1.569	1.724	1.775	2.078	2.308	2.879
0,75	39	4,5	6,5	'	+10%	Rivestimento / Replacement cover	565	642	740	892	919				

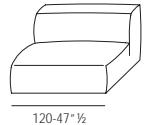
						200008		1.598	1.653	1.758	1.935	1.994	2.336	2.596	3.234
0,92	45	4,5	7,5	'	+10%	Rivestimento / Replacement cover	637	719	824	1.001	1.030				

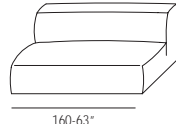
						200009		1.996	2.067	2.198	2.418	2.491	2.919	3.244	4.043
1,3	65	8,5	12	'	+10%	Rivestimento / Replacement cover	794	898	1.030	1.251	1.289				

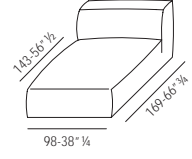
						200010		1.860	1.925	2.049	2.254	2.323	2.719	3.022	3.767
1,5	55	6	8,5	'	+10%	Rivestimento / Replacement cover	740	839	961	1.167	1.203				

						200011		1.090	1.135	1.228	1.382	1.423	1.738	1.932	2.384
0,45	28	3	4,5	'	+10%	Rivestimento / Replacement cover	443	506	600	754	777				

I prezzi sono espressi in Euro
Prices are in Euro

Consultare condizione di vendita e avvertenze importanti
Please check our sale conditions and important remarks

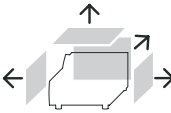
M ³	Kg.	MI.	M ²			 <p>Possibile su misura Special sizes available</p>	Tessuto - Fabric					Pelle - Leather		
Volume Volume	Peso Weight	Tessuto Fabric	Pelle Leather	Imballi legno Wood packaging	Prelavaggio p. 7/10 Prewash p. 7/10		<input type="radio"/> previsto (rif. tab. pag. 3) / available: s.table p.3 <input type="radio"/> incluso / included	Tessuto cliente COM	D - F - Aqua	Extra	Super	Nature	Pelle cliente COL	Pelle

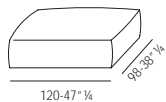

200012

0,55	33	3,2	5,5	'	+10%		1.220	1.277	1.378	1.552	1.598	1.949	2.165	2.672
						Rivestimento / Replacement cover	498	575	677	849	875			

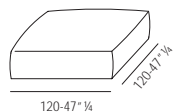

200013

0,65	38	4,5	7	'	+10%		1.463	1.531	1.653	1.854	1.910	2.211	2.456	3.125
						Rivestimento / Replacement cover	598	690	811	1.019	1.049			

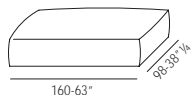

200014

0,92	45	4,5	7,5	'	+10%		1.566	1.620	1.724	1.896	1.952	2.289	2.544	3.170
						Rivestimento / Replacement cover	640	736	868	1.091	1.123			

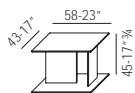

200016

0,12	12			'			571							
------	----	--	--	---	--	--	-----	--	--	--	--	--	--	--

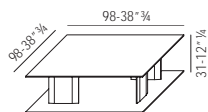

200017

0,30	23			'			1.425							
------	----	--	--	---	--	--	-------	--	--	--	--	--	--	--

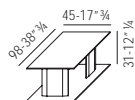

200018

0,14	12			'			855							
------	----	--	--	---	--	--	-----	--	--	--	--	--	--	--

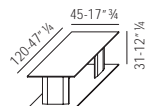

200019

0,17	13,5			'			1.140							
------	------	--	--	---	--	--	-------	--	--	--	--	--	--	--

I prezzi sono espressi in Euro
Prices are in Euro

Consultare condizione di vendita e avvertenze importanti
Please check our sale conditions and important remarks

Il totale delle composizioni potrà non corrispondere a causa di arrotondamenti automatici.

The total amount in compositions may not correspond to the sum of single prices due to automatic rounding.

Q.tà / Qty / Q.té / Stk	Tessuto - Fabric					Pelle - Leather		
	Tessuto cliente COM	D - F - Aqua	Extra	Super	Nature	Pelle cliente COL	Pelle	Pelle Lusso

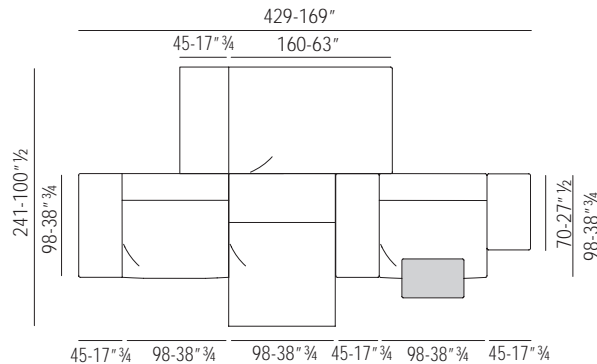

200001	1	238	247	258	297	307	342	382	458
200005	1	495	520	561	640	659	795	883	1.087
200007	1	1.421	1.474	1.569	1.724	1.775	2.078	2.308	2.879
200004	1	523	548	593	666	685	836	928	1.144
200012	1	1.220	1.277	1.378	1.552	1.598	1.949	2.165	2.672
200004	1	523	548	593	666	685	836	928	1.144
200007	1	1.421	1.474	1.569	1.724	1.775	2.078	2.308	2.879
200006	1	458	476	518	588	606	730	811	1.000
200002	1	435	456	495	553	571	697	774	961
200014	1	1.566	1.620	1.724	1.896	1.952	2.289	2.544	3.170
200016	1	587	571	571	571	571	554	554	554
Totale / Total		8.877	9.198	9.817	10.863	11.173	13.179	14.581	17.941

1

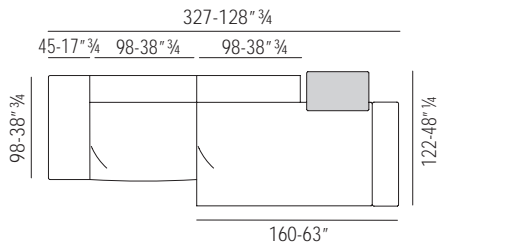

200004	1	523	548	593	666	685	836	928	1.144
200007	1	1.421	1.474	1.569	1.724	1.775	2.078	2.308	2.879
200003	1	513	535	580	651	670	822	914	1.131
200014	1	1.566	1.620	1.724	1.896	1.952	2.289	2.544	3.170
200002	1	435	456	495	553	571	697	774	961
200016	1	587	571	571	571	571	554	554	554
Totale / Total		5.039	5.199	5.526	6.054	6.219	7.272	8.020	9.834

2

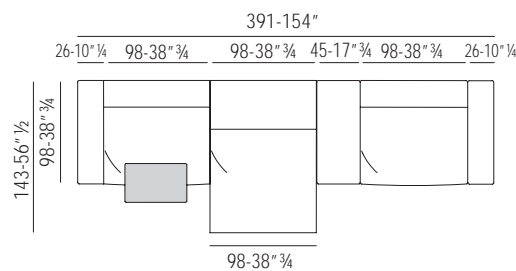

200003	1	513	535	580	651	670	822	914	1.131
200007	1	1.421	1.474	1.569	1.724	1.775	2.078	2.308	2.879
200004	1	523	548	593	666	685	836	928	1.144
200011	1	1.090	1.135	1.228	1.382	1.423	1.738	1.932	2.384
200004	1	523	548	593	666	685	836	928	1.144
200007	1	1.421	1.474	1.569	1.724	1.775	2.078	2.308	2.879
200002	1	435	456	495	553	571	697	774	961
200016	1	587	571	571	571	571	554	554	554
Totale / Total		6.505	6.734	7.192	7.927	8.149	9.633	10.643	13.072

3

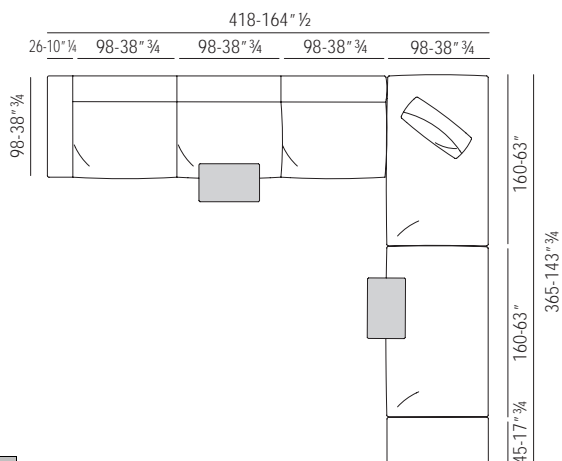

200002	1	435	456	495	553	571	697	774	961
200007	3	4.261	4.418	4.700	5.168	5.323	6.231	6.921	8.634
200014	2	3.131	3.238	3.445	3.903	4.020	4.579	5.087	6.339
200004	1	523	548	593	666	685	836	928	1.144
200015	1	514	513	526	558	576	648	720	814
200016	2	1.174	1.140	1.140	1.140	1.140	1.107	1.107	1.107
Totale / Total		10.031	10.308	10.893	11.984	12.309	14.094	15.534	18.996

4

I prezzi sono espressi in Euro
Prices are in Euro

Consultare condizione di vendita e avvertenze importanti
Please check our sale conditions and important remarks

**Descrizione prodotto**

Divani, terminali, angoli, chaise longue, pouf

Caratteristiche tecniche

Struttura: Massello di abete e legno multistrato.

Molleggio: Nastri elastici unidirezionali ad alta portata.

Imbottitura base e schienale: Poliuretano espanso a quote differenziate e Memory ricoperto in termofalda.

Cuscini schienale: Fibra poliestere siliconata ricoperta da fodera in cotone 100%.

Piedi: Tecnici neri.

Finitura: Cordolo tessuto.

Rivestimento: rivestimento in tessuto o in pelle.

Rivestimento in tessuto completamente sfoderabile.

Note particolari

I cuscini schienale non sono compresi nel costo dei divani.

Nelle composizioni è necessario il disegno.

Description of the product

Sofas, End Elements, Corners, Chaise longue, Ottoman

Technical features

Frame: Solid fir-wood and multilayer

Springing: High resistance unidirectional elastic bands.

Seat and backrest padding: Polyurethane foam with different densities and Memory foam covered with heated bonded polyester fibre.

Back cushions: Silicone polyester fibre covered with 100% cotton lining.

Feet: black standard.

Finishing: Fabric piping.

Cover: Fabric or leather cover.

Fabric cover completely removable.

Special notes

Back cushions are not included in the sofas price.

For compositions, please supply the drawing

Produktbeschreibung

Sofas, Schlusselemente, Ecken, Chaise longue, Hocker

Technische Angaben

Gestell: massives Fichtenholz und Schichtholz.

Federung: Mit hochbelastbaren und unidirektionalen elastischen Gurten.

Sitz- und Rückenlehnpolsterung: Polyurethanschaumstoff in verschiedenen Quoten und Memory mit thermisch gebundenen Fasern.

Rückenkissen: Silikon-Polyester-Fasern mit einem Bezug aus 100% Baumwolle.

FüÙe: Standard Schwarz.

Finish: Stoffkeder

Bezug: Bezug aus Stoff oder Leder.

Stoffbezug ganz abnehmbar.

Bemerkungen

Die Rückenkissen sind extra zu bestellen.

Im Falle von Kombinationen bitte Skizze beilegen.

Description du produit

Canapés, éléments terminaux, angles, chaise longue

Caractéristiques techniques

Structure: Sapin massif et bois multiplis

Suspension: Sangles élastiques unidirectionnelles a haute resistance.

Rembourrage assise et dossiers: Mousse de polyuréthane des différentes densités et Memory enrobée en fibre thermomoulée.

Coussins de dossier: Fibre en polyester siliconée recouverte de coton 100%.

Pieds: Standard noirs.

Finissage: Profil en tissu.

Revêtement: Revêtement en tissu ou en cuir.

Revêtement en tissu entièrement déhoussable.

Remarques

Les coussins de dossier ne sont pas inclus dans le prix des canapés.

Pour les compositions un dessin est indispensable.

- A - Memory foam / Memory foam
- B - Espanso densità portante / Foam supporting density
- C - Espanso densità soft / Foam soft density
- L - Fusto in legno / Wooden frame
- R - Resinato / Heated bonded polyester fibre
- S - Fibra poliestere siliconata / Silicon polyester fibre

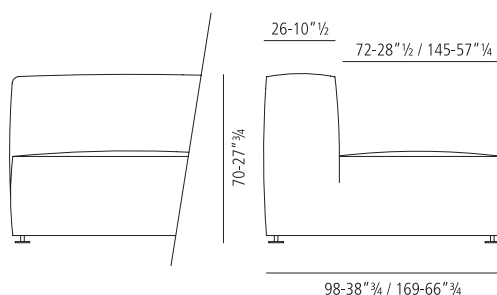
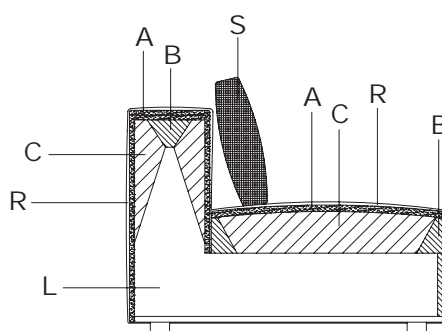

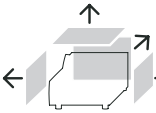
M ³	Kg.	MI.	M ²			Tessuto - Fabric					Pelle - Leather			
Volume Volume	Peso Weight	Tessuto Fabric	Pelle Leather	Imballi legno Wood packaging	Prelavaggio p. 7/10 Prewash p. 7/10	 Possibile su misura Special sizes available	Tessuto cliente COM	D - F - Aqua	Extra	Super	Nature	Pelle cliente COL	Pelle	Pelle Lusso
							<input type="radio"/> previsto (rif. tab. pag. 3) / available: s.table p.3 <input type="radio"/> incluso / included							

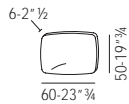

275001

0,05	2	1	1,5		+10%		241	247	258	297	307	342	382	458
						Rivestimento / Replacement cover	151	156	170	210	216	271	301	376

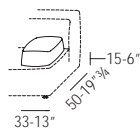

275002

0,03	8	1	1		+10%		353	353	364	396	407	432	480	550
						Rivestimento / Replacement cover	158	167	178	208	215	249	296	367



275005

0,58	33	4,2	5,8	'	+10%		1.473	1.518	1.609	1.753	1.805	2.133	2.369	2.955
						Rivestimento / Replacement cover	620	691	781	926	952			



275006

0,83	39	4,7	7,5	'	+10%		1.611	1.657	1.757	1.917	1.973	2.331	2.590	3.229
						Rivestimento / Replacement cover	681	752	852	1.010	1.041			

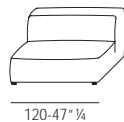

275007

1,01	45	4,7	8,6	'	+10%		1.810	1.862	1.974	2.153	2.218	2.671	2.968	3.700
						Rivestimento / Replacement cover	729	811	923	1.095	1.128			



275008

1,11	45	5,7	10,5	'	+10%		2.410	2.479	2.629	2.867	2.953	3.259	3.621	4.444
						Rivestimento / Replacement cover	1.128	1.236	1.384	1.621	1.671			

I prezzi sono espressi in Euro
Prices are in Euro

Consultare condizione di vendita e avvertenze importanti
Please check our sale conditions and important remarks

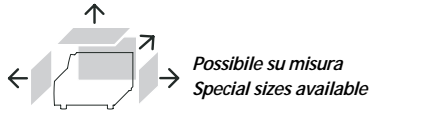
M ³	Kg.	MI.	M ²			Tessuto - Fabric					Pelle - Leather			
Volume Volume	Peso Weight	Tessuto Fabric	Pelle Leather	Imballi legno Wood packaging	Prelavaggio p. 7/10 Prewash p. 7/10		Tessuto cliente COM	D - F - Aqua	Extra	Super	Nature	Pelle cliente COL	Pelle	Pelle Lusso
							<input type="radio"/> previsto (rif. tab. pag. 3) / available: s.table p.3 <input type="radio"/> incluso / included							

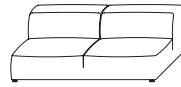

196-77*¼

275009

1,63	67	8,7	11	'	+10%		2.581	2.659	2.818	3.070	3.163	3.491	3.879	4.715
						Rivestimento / Replacement cover	1.222	1.338	1.495	1.749	1.801			

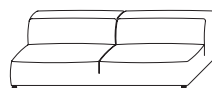

240-94*½

275010

1,99	78	9,7	15,5	'	+10%		2.833	2.917	3.092	3.387	3.487	3.833	4.259	5.294
						Rivestimento / Replacement cover	1.308	1.438	1.611	1.903	1.961			

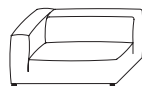

144-56*¾

275013

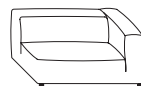

275012

1,23	59	7,5	11,5	'	+10%		2.569	2.657	2.833	3.117	3.209	3.921	4.356	5.405
						Rivestimento / Replacement cover	1.188	1.314	1.490	1.772	1.827			

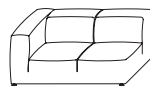

156-61*½

275015



275014

1,33	69	8,5	13	'	+10%		3.203	3.312	3.526	3.872	3.989	4.562	5.069	6.222
						Rivestimento / Replacement cover	1.586	1.739	1.955	2.299	2.368			



220-86*¾

275017

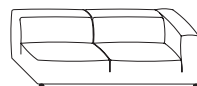

275016

1,87	81	11,5	16	'	+10%		3.374	3.489	3.713	4.074	4.197	4.793	5.325	6.495
						Rivestimento / Replacement cover	1.680	1.842	2.067	2.426	2.498			

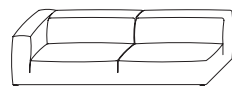

264-104*

275019

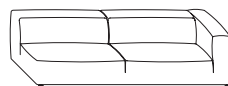

275018

2,21	92	11,5	18	'	+10%		3.627	3.750	3.990	4.389	4.520	5.136	5.705	7.073
						Rivestimento / Replacement cover	1.765	1.940	2.180	2.581	2.657			

I prezzi sono espressi in Euro
Prices are in Euro

Consultare condizione di vendita e avvertenze importanti
Please check our sale conditions and important remarks

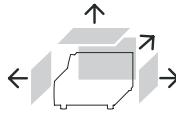
M ³	Kg.	MI.	M ²			Tessuto - Fabric					Pelle - Leather			
Volume Volume	Peso Weight	Tessuto Fabric	Pelle Leather	Imballi legno Wood packaging	Prelavaggio p. 7/10 Prewash p. 7/10	 <p>Possibile su misura Special sizes available</p>	Tessuto cliente COM	D - F - Aqua	Extra	Super	Nature	Pelle cliente COL	Pelle	Pelle Lusso
							<input type="radio"/> previsto (rif. tab. pag. 3) / available: s.table p.3 <input type="radio"/> incluso / included							

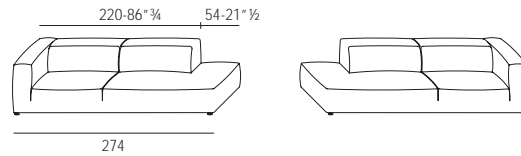

2,21	99	12	20,5	'	+10%	275020	275021	4.140	4.276	4.550	4.987	5.137	5.830	6.478	7.876	
								Rivestimento / Replacement cover	1.831	2.033	2.306	2.745	2.827			

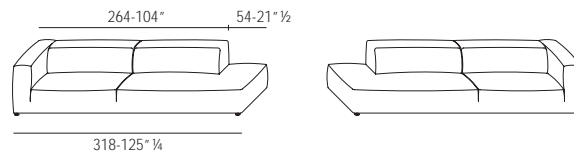

2,65	109	12	20,5	'	+10%	275022	275023	4.393	4.537	4.818	5.301	5.460	6.174	6.859	8.454	
								Rivestimento / Replacement cover	1.939	2.152	2.434	2.916	3.002			

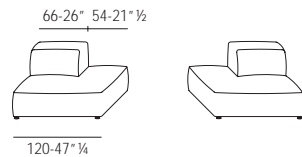

1,02	52	5,2	7,5	'	+10%	275024	275025	2.237	2.306	2.447	2.665	2.745	3.171	3.522	4.336	
								Rivestimento / Replacement cover	983	1.086	1.226	1.444	1.488			

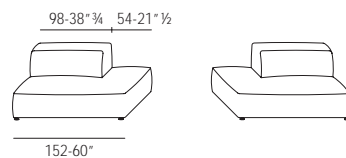

1,4	60	6	8,5	'	+10%	275026	275027	2.376	2.447	2.595	2.827	2.912	3.368	3.742	4.610	
								Rivestimento / Replacement cover	1.046	1.154	1.301	1.534	1.581			

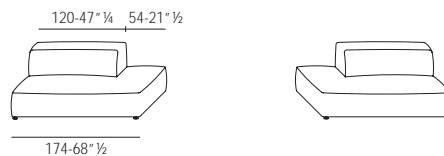

1,5	70	6	10	'	+10%	275028	275029	2.540	2.614	2.774	3.023	3.114	3.654	4.059	5.011	
								Rivestimento / Replacement cover	1.117	1.233	1.393	1.639	1.688			

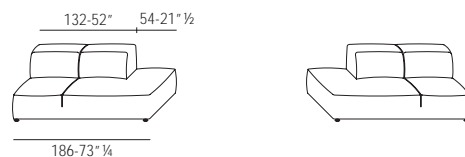

1,6	75	6,7	10,5	'	+10%	275030	275031	3.174	3.270	3.467	3.777	3.892	4.296	4.773	5.827	
								Rivestimento / Replacement cover	1.395	1.541	1.738	2.049	2.111			

I prezzi sono espressi in Euro
Prices are in Euro

Consultare condizione di vendita e avvertenze importanti
Please check our sale conditions and important remarks

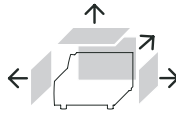
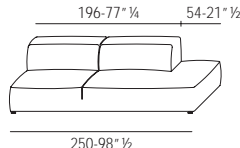
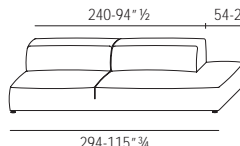
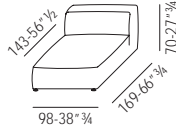
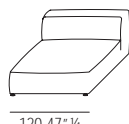
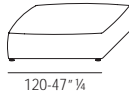
M ³	Kg.	MI.	M ²			Tessuto - Fabric					Pelle - Leather			
Volume Volume	Peso Weight	Tessuto Fabric	Pelle Leather	Imballi legno Wood packaging	Prelavaggio p. 7/10 Prewash p. 7/10	 Possibile su misura Special sizes available	Tessuto cliente COM	D - F - Aqua	Extra	Super	Nature	Pelle cliente COL	Pelle	Pelle Lusso
							<input type="radio"/> previsto (rif. tab. pag. 3) / available: s.table p.3 incluso / included							
						275032	3.349	3.447	3.655	3.982	4.102	4.528	5.031	6.099
2,08	85	9,7	12	'	+10%		1.470	1.623	1.832	2.158	2.224			
						275033	3.599	3.707	3.930	4.296	4.424	4.871	5.412	6.676
2,42	95	11,5	16,5	'	+10%		1.583	1.745	1.967	2.334	2.404			
						275034	2.166	2.230	2.364	2.575	2.652	3.050	3.388	4.224
1,5	55	6,5	9	'	+10%		952	1.049	1.186	1.398	1.441			
						275035	2.414	2.487	2.634	2.872	2.957	3.382	3.759	4.689
1,73	67	7	9,5	'	+10%		1.061	1.173	1.322	1.557	1.604			
						275036	1.356	1.417	1.526	1.711	1.763	2.201	2.444	2.998
0,55	33	3,2	5,5	'	+10%		611	693	806	989	1.019			

<p><i>Il totale delle composizioni potrà non corrispondere a causa di arrotondamenti automatici.</i></p> <p><i>The total amount in compositions may not correspond to the sum of single prices due to automatic rounding.</i></p>	Q.ta / Qty / Q.té / Stk	Tessuto - Fabric					Pelle - Leather		
		Tessuto cliente COM	D - F - Aqua	Extra	Super	Nature	Pelle cliente COL	Pelle	Pelle Lusso

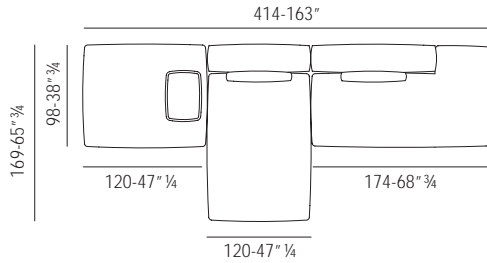

275040	1	1.356	1.417	1.526	1.711	1.763	2.201	2.444	2.998
275002	1	353	353	364	396	407	432	480	550
275037	1	2.414	2.487	2.634	2.872	2.957	3.382	3.759	4.689
275028	1	2.540	2.614	2.774	3.023	3.114	3.654	4.059	5.011
275001	2	481	491	514	593	613	684	763	915
Totale / Total		7.140	7.359	7.808	8.590	8.850	10.352	11.503	14.161

1

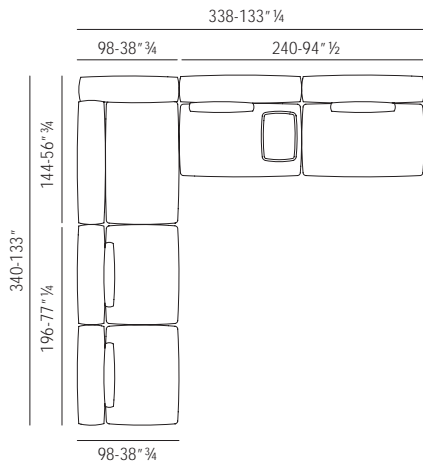

275009	1	2.581	2.659	2.818	3.070	3.163	3.491	3.879	4.715
275012	1	2.569	2.657	2.833	3.117	3.209	3.921	4.356	5.405
275010	1	2.833	2.917	3.092	3.387	3.487	3.833	4.259	5.294
275002	1	353	353	364	396	407	432	480	550
275001	4	961	981	1.028	1.186	1.224	1.368	1.525	1.830
Totale / Total		9.292	9.564	10.131	11.152	11.487	13.043	14.497	17.792

2

**Descrizione prodotto**

Divani, terminali, divani componibili, chaise longue, pouf

Caratteristiche tecniche

Struttura base: Metallo verniciato a fuoco, telaio in legno multistrato.

Struttura schienale/bracciolo: Massello di abete e legni composti.

Molleggio: Nastri elastici unidirezionali ad alta portata.

Imbottitura base e schienale: Poliuretano espanso a quote differenziate e Memory, ricoperto in termofalda.

Cuscino seduta: In poliuretano espanso a quote differenziate ricoperto in termolegato cotone 100%.

Cuscini schienale: In fibra poliestere siliconata ricoperta da fodera in cotone 100%.

Piedi: In metallo verniciato brunito.

Rivestimento: Rivestimento in tessuto o in pelle. Rivestimento in tessuto completamente sfoderabile.

Note particolari

Nelle composizioni è necessario il disegno.

Description of the product

Sofas, End Elements, Unit sofas, Chaise longue, Ottoman

Technical features

Frame base: Baked varnished metal, composite wooden frame.

Frame backrest/arm: Solid fir-wood and composite woods.

Springing: High resistance unidirectional elastic bands.

Base and backrest padding: Polyurethane foam with different densities and Memory foam covered with heated bonded polyester fibre.

Seat cushion: Polyurethane foam with different densities covered with heated bonded polyester fibre.

Back cushion: Silicone polyester fibre covered with 100% cotton lining.

Feet: Burnish varnished metal.

Cover: Fabric or leather cover.

Fabric cover completely removable.

Special notes

For compositions, please supply the drawing.

Produktbeschreibung

Sofas, Schlusselemente, Anbauelemente, Chaise longue, Hocker.

Technische Angaben

Korpusgestell: Ofenlackiertes Metall, Rahmengestell aus Schichtholz.

Gestell der Arm-/Rückenlehne: Aus massivem Fichtenholz und Agglomerat.

Federung: Mit hochbelastbaren und unidirektionalen elastischen Gurten.

Gestell-und Rückenlehnpolsterung: aus Polyurethanschaumstoff in verschiedenen Quoten und Memory mit Abdeckung aus thermisch gebundenen Fasern.

Sitzkissen: aus Polyurethanschaumstoff in verschiedenen Quoten mit Abdeckung aus thermisch gebundenen Fasern mit 100% Baumwollschicht.

Rückenkissen: Silikon-Polyester-Fasern mit einem Bezug aus 100% Baumwolle.

FüÙe: Brünriertes lackiertes Metall.

Bezug: Bezug aus Stoff oder Leder.

Stoffbezug ganz abnehmbar

Bemerkungen

Im Falle von Kombinationen bitte Skizze beilegen.

Description du produit

Canapés, Eléments terminaux, Canapés modulables, Chaise longue, Pouf

Caractéristiques techniques

Structure base: Métal verni à chaud, chassis en bois multiplis.

Structure dos/accoudoir: sapin massif et agglomérat.

Suspension: Sangles élastiques unidirectionnelles à haute résistance.

Rembourrage assise et dossier: Mousse de polyurethane de différentes densités et Memory, enrobée en fibre thermomoulée recouverte de coton 100%.

Coussins dossier: Fibre en polyester siliconé recouverte de coton 100%.

Pieds: En métal verni bruni.

Revêtement: Revêtement en tissu ou en cuir.

Revêtement en tissu entièrement déhoussable.

Remarques

Pour les compositions un dessin est indispensable.

- A - Memory foam / Memory foam
- B - Espanso densità portante / Foam supporting density
- C - Espanso densità soft / Foam soft density
- F - Telaio in ferro / Iron frame
- L - Fusto in legno / Wooden frame
- R - Resinato / Heated bonded polyester fibre
- S - Fibra poliestere siliconata / Silicon polyester fibre

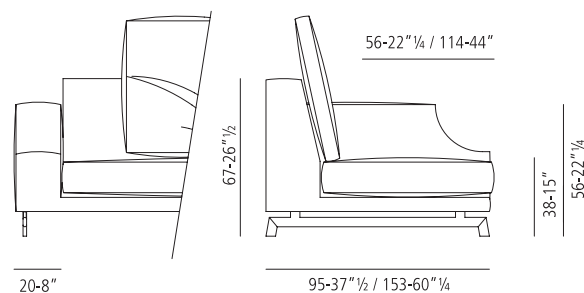
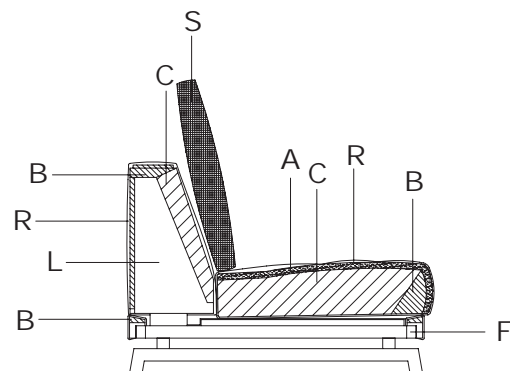

M ³	Kg.	MI.	M ²			Tessuto - Fabric					Pelle - Leather				
Volume Volume	Peso Weight	Tessuto Fabric	Pelle Leather	Imballi legno Wood packaging	Prelavaggio p. 7/10 Prewash p. 7/10	Tessuto cliente COM	D - F - Aqua	Extra	Super	Nature	Pelle cliente COL	Pelle	Pelle Lusso		
						310001	154	156	165	189	195	218	242	289	
						310002	216	223	234	270	278	311	346	415	
						310003	267	280	300	339	349	405	450	550	
0,06	4	1	1,4		+10%	Rivestimento / Replacement cover	123	140	161	200	206	290	323	422	
						310004									
							3.934	4.050	4.292	4.636	4.775	5.111	5.680	6.929	
1,36	130	12,5	18,5		+10%	Rivestimento / Replacement cover	1.839	2.010	2.248	2.587	2.664				
						310005									
							4.275	4.401	4.667	5.042	5.192	5.556	6.173	7.530	
1,61	138	13	20,5		+10%	Rivestimento / Replacement cover	1.996	2.186	2.442	2.808	2.893				
						310006									
							4.275	4.401	4.667	5.042	5.192	5.556	6.173	7.530	
1,61	123	12,5	22		+10%	Rivestimento / Replacement cover	1.917	2.107	2.364	2.731	2.813				
						310009									
							3.517	3.623	3.840	4.146	4.271	4.570	5.078	6.191	
1,23	108	10,5	16,5		+10%	Rivestimento / Replacement cover	1.642	1.798	2.010	2.310	2.379				
						310011									
							3.855	3.974	4.210	4.549	4.686	5.013	5.570	6.794	
1,48	117	12	18,5		+10%	Rivestimento / Replacement cover	1.801	1.971	2.204	2.535	2.611				

I prezzi sono espressi in Euro
Prices are in Euro

Consultare condizione di vendita e avvertenze importanti
Please check our sale conditions and important remarks

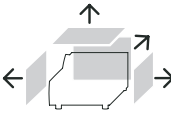
M ³	Kg.	MI.	M ²			Tessuto - Fabric					Pelle - Leather				
Volume Volume	Peso Weight	Tessuto Fabric	Pelle Leather	Imballi legno Wood packaging	Prelavaggio p. 7/10 Prewash p. 7/10	Tessuto cliente COM	D - F - Aqua	Extra	Super	Nature	Pelle cliente COL	Pelle	Pelle Lusso		
						 <p>Possibile su misura Special sizes available</p>									
						<input type="radio"/> previsto (rif. tab. pag. 3) / available: s.table p.3 incluso / included									

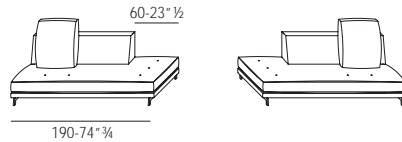

1,23	100	9,5	16	'	+10%	310012	310013	3.517	3.623	3.840	4.146	4.271	4.570	5.078	6.191
							Rivestimento / Replacement cover	1.576	1.733	1.946	2.247	2.315			

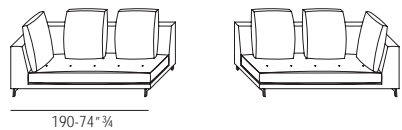

1,23	113	12,5	17,5	'	+10%	310015	310014	3.903	4.018	4.259	4.599	4.737	5.073	5.637	6.875
							Rivestimento / Replacement cover	1.823	2.152	2.389	2.723	2.805			

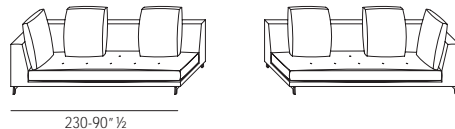

1,48	123	14	19	'	+10%	310017	310016	4.242	4.370	4.632	5.004	5.153	5.517	6.130	7.477
							Rivestimento / Replacement cover	1.981	2.168	2.426	2.789	2.872			

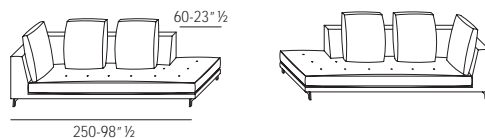

1,61	128	15	21	'	+10%	310018	310019	4.660	4.802	5.087	5.496	5.661	6.060	6.733	8.211
							Rivestimento / Replacement cover	2.092	2.298	2.580	2.978	3.067			

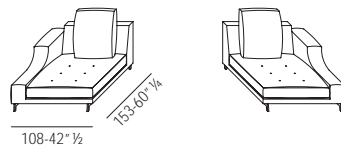

1,11	112	9	14,5	'	+10%	310021	310020	3.517	3.623	3.840	4.146	4.271	4.570	5.078	6.192
							Rivestimento / Replacement cover	1.642	1.798	2.010	2.310	2.379			

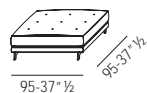

0,63	44	3,5	5	'	+10%	310022		1.771	1.827	1.935	2.091	2.155	2.304	2.560	3.122
							Rivestimento / Replacement cover	763	842	949	1.101	1.135			

I prezzi sono espressi in Euro
Prices are in Euro

Consultare condizione di vendita e avvertenze importanti
Please check our sale conditions and important remarks

Il totale delle composizioni potrà non corrispondere a causa di arrotondamenti automatici.

The total amount in compositions may not correspond to the sum of single prices due to automatic rounding.

Q.tà / Qty / Q.té / Stk	Tessuto - Fabric					Pelle - Leather		
	Tessuto cliente COM	D - F - Aqua	Extra	Super	Nature	Pelle cliente COL	Pelle	Pelle Lusso

1

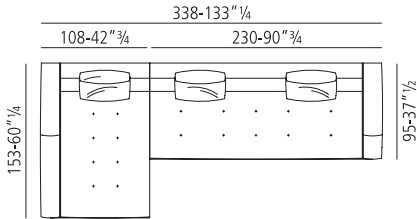

310021	1	3.693	3.803	4.031	4.353	4.484	4.798	5.332	6.502
310010	1	4.048	4.172	4.421	4.776	4.921	5.264	5.848	7.134
Totale / Total		7.740	7.973	8.450	9.127	9.401	10.061	11.179	13.635

2

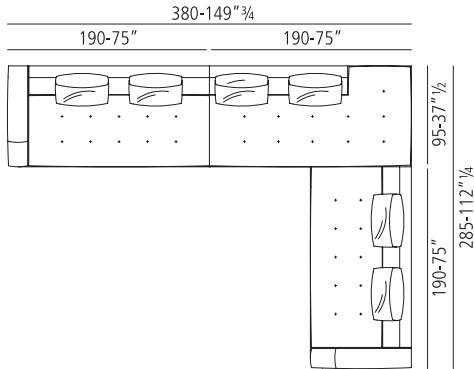

310009	1	3.693	3.803	4.031	4.353	4.484	4.798	5.332	6.501
310012	1	3.693	3.803	4.031	4.353	4.484	4.798	5.332	6.501
310008	1	3.693	3.803	4.031	4.353	4.484	4.798	5.332	6.501
310002	1	228	234	247	283	293	326	363	436
Totale / Total		11.303	11.638	12.336	13.340	13.739	14.720	16.355	19.936

3

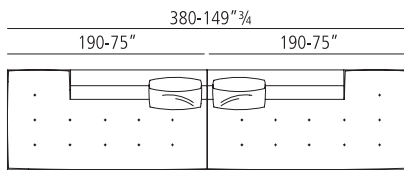

310013	1	3.693	3.803	4.031	4.353	4.484	4.798	5.332	6.501
310012	1	3.693	3.803	4.031	4.353	4.484	4.798	5.332	6.501
Totale / Total		7.384	7.604	8.062	8.705	8.967	9.597	10.663	13.001

4

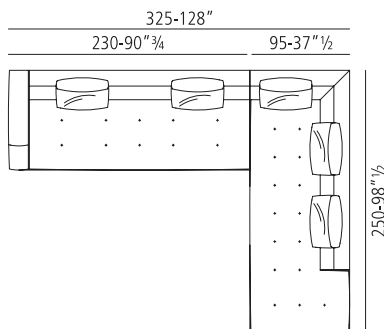

310011	1	4.048	4.176	4.421	4.776	4.921	5.264	5.848	7.134
310018	1	4.892	5.042	5.341	5.771	5.944	6.362	7.069	8.621
Totale / Total		8.940	9.216	9.761	10.544	10.861	11.624	12.917	15.755

I prezzi sono espressi in Euro
Prices are in Euro

Consultare condizione di vendita e avvertenze importanti
Please check our sale conditions and important remarks



Descrizione prodotto

Poltroncina, poltrona, divani, dormeuse, divano curvo, chaise longue

Caratteristiche tecniche

Struttura: massello di abete e legno multistrato.

Molleggio: nastri elastici unidirezionali ad alta portata.

Imbottitura: poliuretano espanso a quote differenziate e memory foam ricoperto in termolegato cotone 100%.

Piedi: legno rovere tinto nero.

Poltroncina: piastra girevole in metallo nero.

Rivestimento: in tessuto o in pelle non sfoderabile.

Note particolari

I cuscini schienale non sono compresi nel costo dei divani.

Description of the product

Small armchair, armchair, sofas, dormeuse, curved sofa, chaise longue

Technical features

Frame: solid fir-wood and multilayer.

Springing: high resistance unidirectional elastic bands.

Seat and backrest padding: polyurethane foam with different densities and memory foam covered with heated bonded with 100% cotton lining.

Feet: black dyed oak wood.

Small Armchair: black metal swivel base.

Cover: non-removable fabric or leather cover.

Special notes

Back cushions are not included in the sofas price.

Produktbeschreibung

Kleine Sessel, Sessel, Sofas, Dormeuse, gebogenes Sofa, Chaise longue

Technische Angaben

Gestell: aus massivem Fichtenholz und Schichtholz.

Federung: mit hochbelastbaren und unidirektionalen elastischen Gurten.

Polsterung: Polyurethanschaumstoff in verschiedenen Quoten und Memory mit thermisch gebundenen Fasern und 100% Baumwollbezug.

FüÙe: Schwarzgebeizte Eiche.

Kleine Sessel: Schwarzes Metall Drehteller.

Bezug: in Stoff oder Leder, nicht abnehmbar.

Bemerkungen

Die Rückenkissen sind extra zu bestellen.

Description du produit

Petite fauteuil, fauteuil, canapés, dormeuse, canapé incurvé, chaise longue

Caractéristiques techniques

Structure: sapin massif et multiplis.

Suspension: sangles élastiques unidirectionnelles à haute résistance.

Rembourrage assise et dossier: mousse di polyurethane de différentes densités et memory, enrobée en fibre thermomoulée recouverte de coton 100%.

Pieds: chêne noir.

Petite fauteuil: base tournante en métal noir.

Revêtement: en tissu ou en cuir pas déhoussable.

Remarques

Les coussins de dossier ne sont pas inclus dans les canapés.

- B - Espanso densità portante / Foam supporting density
- C - Espanso densità soft / Foam soft density
- D - Espanso morbido /
- L - Fusto in legno / Wooden frame
- R - Resinato / Heated bonded polyester fibre

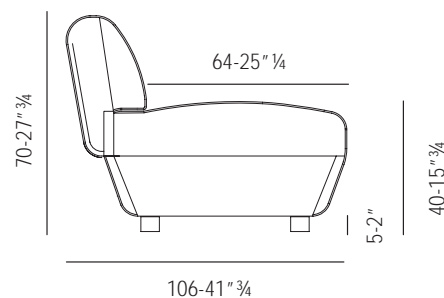
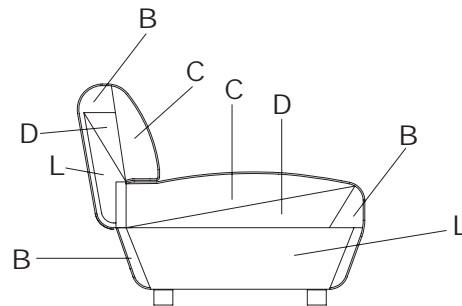

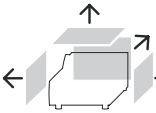
M ³	Kg.	MI.	M ²		 <p>Possibile su misura Special sizes available</p>	Tessuto - Fabric					Pelle - Leather		
Volume Volume	Peso Weight	Tessuto Fabric	Pelle Leather	Imballi legno Wood packaging		<input type="radio"/> previsto (rif. tab. pag. 3) / available: s.table p.3 <input type="radio"/> incluso / included	Tessuto cliente COM	D - F - Aqua	Extra	Super	Nature	Pelle cliente COL	Pelle

						360006														
0,03	3	0,8	0,8																	
							Rivestimento / Replacement cover	159	161	171	193	200	223	248	298					
								111	115	126	149	154	185	206	256					

						360007														
0,04	4	1	1,1																	
							Rivestimento / Replacement cover	225	229	241	278	287	322	357	428					
								138	146	158	195	201	252	280	350					

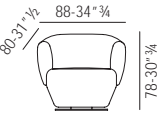
						360008													
0,60	35	5	8	'															
								3.017	3.122	3.323	3.618	3.727	4.067	4.519	5.603				

						360001													
0,90	40	8,5	12	'															
								3.486	3.617	3.769	4.104	4.228	4.519	5.020	6.226				

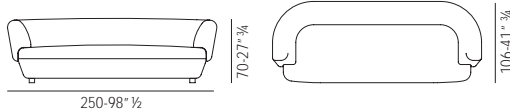
						360002													
1,70	70	12	16	'															
								5.377	5.486	5.647	6.043	6.224	6.140	6.823	8.210				

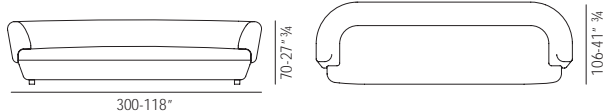
						360003													
2,00	85	14,5	19	'															
								6.324	6.452	6.639	7.105	7.317	7.223	8.025	9.631				

I prezzi sono espressi in Euro
Prices are in Euro

Consultare condizione di vendita e avvertenze importanti
Please check our sale conditions and important remarks

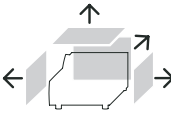
M ³	Kg.	MI.	M ²			Tessuto - Fabric					Pelle - Leather			
Volume Volume	Peso Weight	Tessuto Fabric	Pelle Leather	Imballi legno Wood packaging	Prelavaggio p. 7/10 Prewash p. 7/10	 <p>Possibile su misura Special sizes available</p>	Tessuto cliente COM	D - F - Aqua	Extra	Super	Nature	Pelle cliente COL	Pelle	Pelle Lusso
<input type="checkbox"/> previsto (rif. tab. pag. 3) / available: s.table p.3 incluso / included														

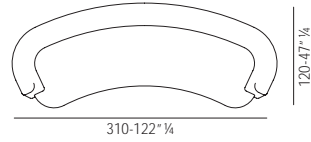

360009

2,60	90	16	21	'		6.488	6.620	6.952	7.438	7.662	7.801	8.668	10.401
------	----	----	----	---	--	-------	-------	-------	-------	-------	-------	-------	--------

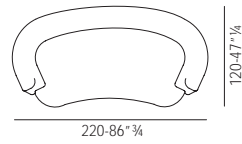

360012

1,70	55	13	16	'		5.320	5.428	5.700	6.099	6.283	6.397	7.107	8.529
------	----	----	----	---	--	-------	-------	-------	-------	-------	-------	-------	-------

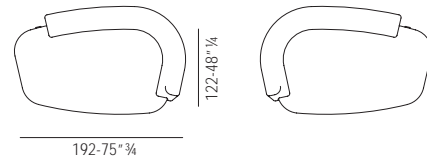

360011

360010

1,80	55	12	16	'		5.377	5.486	5.647	6.043	6.224	6.140	6.823	8.210
------	----	----	----	---	--	-------	-------	-------	-------	-------	-------	-------	-------



Descrizione prodotto

Divani, penisola

Caratteristiche tecniche

Struttura: massello di abete e legno multistrato.

Molleggio: nastri elastici unidirezionali ad alta portata.

Imbottitura: poliuretano espanso a quote differenziate e memory foam ricoperto in termolegato cotone 100%.

Piedi: tecnici neri.

Rivestimento: in tessuto o in pelle non sfoderabile.

Note particolari

I cuscini schienale non sono compresi nel costo dei divani.

Description of the product

Sofas, end element.

Technical features

Frame: solid fir-wood and multilayer.

Springing: high resistance unidirectional elastic bands.

Seat and backrest padding: polyurethane foam with different densities and memory foam covered with heated bonded with 100% cotton lining.

Feet: black standard.

Cover: non-removable fabric or leather cover.

Special notes

Back cushions are not included in the sofas price.

Produktbeschreibung

Sofas, Halbinsel.

Technische Angaben

Gestell: aus massivem Fichtenholz und Schichtholz.

Federung: mit hochbelastbaren und unidirektionalen elastischen Gurten.

Polsterung: Polyurethanschaumstoff in verschiedenen Quoten und Memory mit thermisch gebundenen Fasern und 100% Baumwollbezug.

FüÙe: Standard schwarz.

Bezug: in Stoff oder Leder, nicht abnehmbar.

Bemerkungen

Die Rückenissen sind extra zu bestellen.

Description du produit

Canapés; méridienne.

Caractéristiques techniques

Structure: sapin massif et multiplis.

Suspension: sangles élastiques unidirectionnelles à haute résistance.

Rembourrage assise et dossier: mousse di polyurethane de différentes densités et memory, enrobée en fibre thermomoulée recouverte de coton 100%.

Finition piètement: standard noir

Revêtement: en tissu ou en cuir pas déhoussable.

Remarques

Les coussins de dossier ne sont pas inclus dans les canapés.

B - Espanso densità portante / Foam supporting density

C - Espanso densità soft / Foam soft density

D - Espanso morbido /

L - Fusto in legno / Wooden frame

R - Resinato / Heated bonded polyester fibre

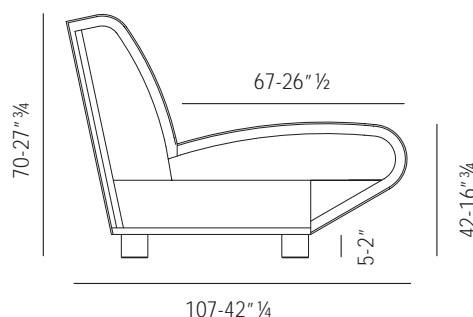
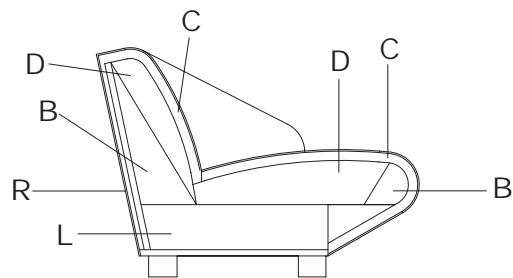

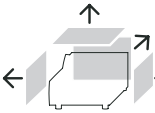
M ³	Kg.	MI.	M ²			Tessuto - Fabric					Pelle - Leather			
Volume Volume	Peso Weight	Tessuto Fabric	Pelle Leather	Imballi legno Wood packaging	Prelavaggio p. 7/10 Prewash p. 7/10	 <p>Possibile su misura Special sizes available</p>	Tessuto cliente COM	D - F - Aqua	Extra	Super	Nature	Pelle cliente COL	Pelle	Pelle Lusso
					<input type="radio"/> previsto (rif. tab. pag. 3) / available: s.table p.3 <input type="radio"/> incluso / included									

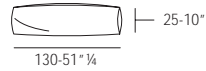

370006

0,03	2	0,7	2				206	208	226	255	262	311	346	415
						Rivestimento / Replacement cover	123	125	137	153	158	186	207	250

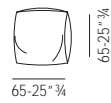

370005

0,05	3	0,7	1,4				173	174	189	213	219	260	289	346
						Rivestimento / Replacement cover	100	102	116	143	147	201	223	280

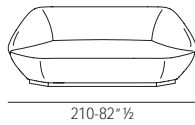

370001

1,75	60	11	17	'			5.154	5.259	5.521	5.907	6.085	6.337	7.040	8.448
------	----	----	----	---	--	--	-------	-------	-------	-------	-------	-------	-------	-------



370002

2,20	80	13,5	21	'			6.063	6.186	6.493	6.950	7.158	7.455	8.283	10.265
------	----	------	----	---	--	--	-------	-------	-------	-------	-------	-------	-------	--------

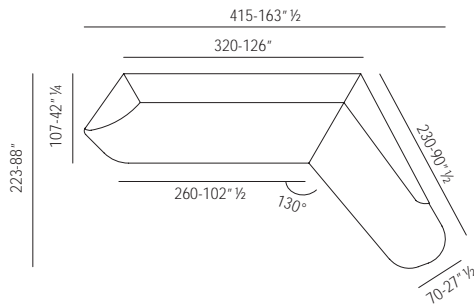

370003

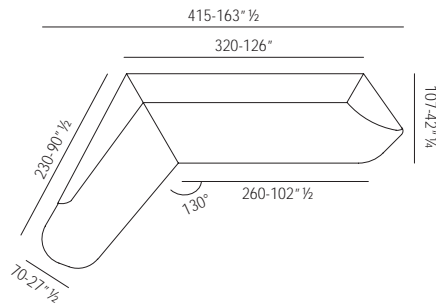

370004

3,60	100	25	33	'			10.442	10.654	11.080	11.634	11.982	12.198	13.553	16.052
------	-----	----	----	---	--	--	--------	--------	--------	--------	--------	--------	--------	--------

I prezzi sono espressi in Euro
Prices are in Euro

Consultare condizione di vendita e avvertenze importanti
Please check our sale conditions and important remarks



Descrizione prodotto

Divani, divani componibili, chaises longues, pouf

Caratteristiche tecniche

- Struttura:** Massello di abete e legno multistrato con inserti in legni composti.
- Molleggio:** Nastri elastici unidirezionali ad alta portata.
- Imbottitura:** Poliuretano espanso ricoperto con resinato accoppiato vellutino.
- Cuscini seduta:** Poliuretano espanso ricoperto in termolegato cotone 100%.
- Cuscini schienale:** fibra siliconata ricoperta da fodera cotone 100%.
- Piedi:** legno tinto moka.
- Rivestimento:** Rivestimento in tessuto completamente sfoderabile.

Description of the product

Sofas, Unit sofas, chaises longues, ottoman

Technical features

- Frame:** Solid fir-wood and multilayer and composite woods.
- Springing:** High resistance unidirectional elastic bands
- Padding:** Polyurethane foam covered with heated bonded polyester fibre.
- Seat cushions:** Polyurethane foam covered with 100% cotton lining.
- Back cushions:** Silicone polyester fibre covered with 100% cotton lining.
- Feet:** moka dyed wood.
- Cover:** Fabric cover completely removable.

Produktbeschreibung

Sofas, Anbauelemente, Chaises longues, Hocker

Technische Angaben

- Gestell:** Aus massivem Fichtenholz, Schichtholz und Agglomerateinlagen.
- Federung:** Mit hochbelastbaren und unidirektionalen elastischen Gurten.
- Polsterung:** Polyurethanschaumstoff mit thermisch gebundenen Fasern und samtartiger Resinatbedeckung
- Sitzkissen:** Polyurethanschaumstoff mit thermisch gebundenen Fasern mit 100% Baumwollbezug.
- Rückenkissen:** Silikon-Polyester-Fasern mit einem Bezug aus 100% Baumwolle.
- FüÙe:** mokkagebeizte Holz.
- Bezug:** Stoffbezug ganz abnehmbar.

Description du produit

Canapés, canapés modulables, chaises longues, pouf

Caractéristiques techniques

- Structure:** Sapin massif, bois multiplis et agglomérat.
- Suspension:** Sangles élastiques unidirectionnelles à haute résistance.
- Rembourrage:** Mousse de polyuréthane de différentes densités, enrobée en fibre thermomoullée.
- Coussins d'assise:** Mousse de polyuréthane enrobée en fibre thermomoullée recouverte de coton 100%.
- Coussins de dossier:** Fibre en polyester siliconée recouverte de coton 100%.
- Pieds:** bois teinté moka.
- Revêtement:** Revêtement en tissu entièrement déhoussable.

- B - Espanso densità portante / Foam supporting density
- C - Espanso densità soft / Foam soft density
- L - Fusto in legno / Wooden frame
- F - Fibra siliconata / Silicone polyester fibre
- R - Resinato / Heated bonded polyester fibre

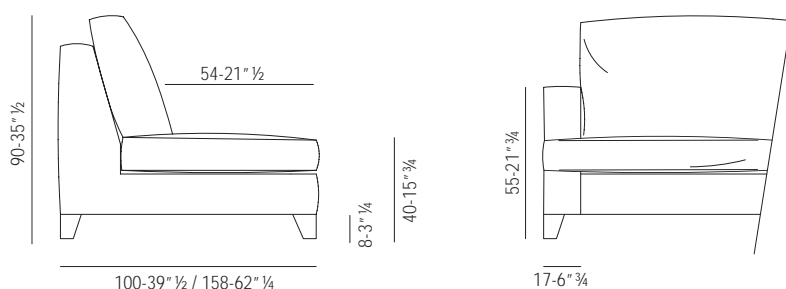
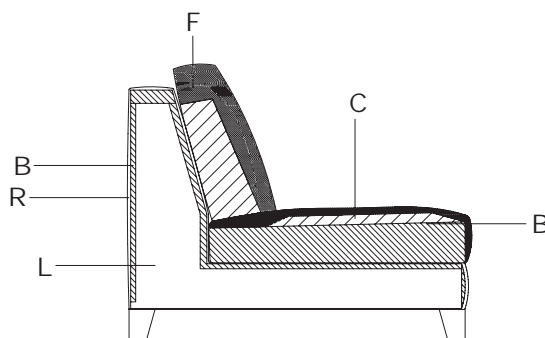

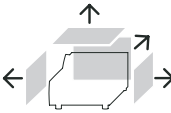
M ³	Kg.	MI.	M ²			Tessuto - Fabric					Pelle - Leather			
Volume Volume	Peso Weight	Tessuto Fabric	Pelle Leather	Imballi legno Wood packaging	Prelavaggio p. 7/10 Prewash p. 7/10	 <p>Possibile su misura Special sizes available</p>	Tessuto cliente COM	D - F - Aqua	Extra	Super	Nature	Pelle cliente COL	Pelle	Pelle Lusso
							<input type="radio"/> previsto (rif. tab. pag. 3) / available: s.table p.3 <input type="radio"/> incluso / included							



122-48*¼

400001

0,90	92	11,5	15	'	10%		2.643	2.749	2.967	3.254	3.351	3.826	4.251	5.233
						Rivestimento / Replacement cover	1.322	1.465	1.683	1.970	2.068			

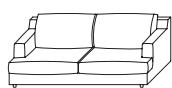

207-81*½

400002

1,60	115	18,3	22,4	'	10%		3.870	4.011	4.295	4.664	4.805	5.489	6.099	7.490
						Rivestimento / Replacement cover	1.935	2.130	2.414	2.785	2.925			

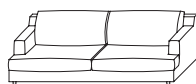

247-97*¼

400003

1,90	126	18,3	24	'	10%		4.100	4.249	4.550	4.943	5.091	5.811	6.457	7.949
						Rivestimento / Replacement cover	2.051	2.256	2.559	2.952	3.099			

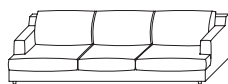

295-116*¼

400004

2,25	142	20,5	30	'	10%		5.016	5.198	5.564	6.042	6.222	7.097	7.887	9.700
						Rivestimento / Replacement cover	2.508	2.761	3.127	3.605	3.787			



88-34*¼

400005

0,70	64	7,7	8,6	'	10%		1.821	1.890	2.044	2.247	2.314	2.618	2.909	3.576
						Rivestimento / Replacement cover	911	1.007	1.160	1.363	1.430			



107-42*¼

400006

0,80	72	9,6	10,5	'	10%		1.931	2.007	2.167	2.373	2.444	2.776	3.084	3.794
						Rivestimento / Replacement cover	966	1.069	1.229	1.436	1.507			

I prezzi sono espressi in Euro
Prices are in Euro

Consultare condizione di vendita e avvertenze importanti
Please check our sale conditions and important remarks

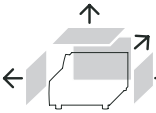
M ³	Kg.	MI.	M ²			Tessuto - Fabric					Pelle - Leather			
Volume Volume	Peso Weight	Tessuto Fabric	Pelle Leather	Imballi legno Wood packaging	Prelavaggio p. 7/10 Prewash p. 7/10	 <p>Possibile su misura Special sizes available</p>	Tessuto cliente COM	D - F - Aqua	Extra	Super	Nature	Pelle cliente COL	Pelle	Pelle Lusso
							<input type="radio"/> previsto (rif. tab. pag. 3) / available: s.table p.3 <input type="radio"/> incluso / included							



135-53*¼

400007

1,00	81	10,6	12	'	10%		2.964	3.068	3.282	3.561	3.669	4.165	4.629	5.693
						Rivestimento / Replacement cover	1.482	1.629	1.843	2.122	2.230			

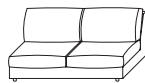

173-68*¼

400008

1,30	88	14,5	16	'	10%		3.047	3.151	3.371	3.658	3.767	4.281	4.757	5.833
						Rivestimento / Replacement cover	1.524	1.672	1.891	2.178	2.287			

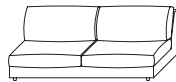

213-83*¾

400009

1,60	99	14,5	17,5	'	10%		3.277	3.389	3.627	3.937	4.053	4.603	5.115	6.293
						Rivestimento / Replacement cover	1.639	1.798	2.036	2.345	2.462			

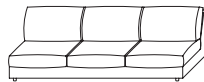

261-102*¾

400010

2	123	16,7	23,6	'	10%		4.193	4.339	4.640	5.035	5.185	5.889	6.545	8.051
						Rivestimento / Replacement cover	2.097	2.302	2.604	2.999	3.149			



106-41*¾

400012



400011

0,81	78	9,6	11,8	'	10%		2.232	2.331	2.506	2.751	2.833	3.222	3.580	4.405
						Rivestimento / Replacement cover	1.116	1.248	1.421	1.666	1.749			



124-48*¾

400014

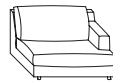

400013

0,95	86	11,5	13,7	'	10%		2.342	2.436	2.629	2.876	2.963	3.380	3.755	4.622
						Rivestimento / Replacement cover	1.172	1.299	1.492	1.739	1.827			

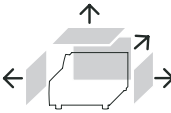
M ³	Kg.	MI.	M ²			Tessuto - Fabric					Pelle - Leather			
Volume Volume	Peso Weight	Tessuto Fabric	Pelle Leather	Imballi legno Wood packaging	Prelavaggio p. 7/10 Prewash p. 7/10	 <p>Possibile su misura Special sizes available</p>	Tessuto cliente COM	D - F - Aqua	Extra	Super	Nature	Pelle cliente COL	Pelle	Pelle Lusso
							<input type="radio"/> previsto (rif. tab. pag. 3) / available: s.table p.3 <input type="radio"/> incluso / included							

						 152-59*¾												
						400016												
1,15	95	12,5	15,2	'	10%		3.375	3.498	3.744	4.065	4.187	4.769	5.300	6.522				
							Rivestimento / Replacement cover	1.688	1.858	2.105	2.426	2.548						

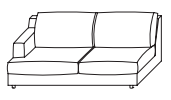
						 190-74*¾												
						400018												
1,45	102	16,4	19,2	'	10%		3.459	3.581	3.833	4.161	4.287	4.885	5.428	6.661				
							Rivestimento / Replacement cover	1.730	1.900	2.153	2.481	2.606						

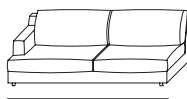
						 230-90*½												
						400020												
1,75	113	16,4	20,7	'	10%		3.688	3.819	4.089	4.439	4.572	5.207	5.786	7.121				
							Rivestimento / Replacement cover	1.845	2.028	2.297	2.648	2.781						

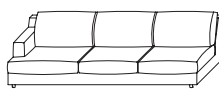
						 278-109*½												
						400022												
2,12	137	18,6	26,8	'	10%		4.604	4.768	5.102	5.539	5.704	6.493	7.216	8.879				
							Rivestimento / Replacement cover	2.302	2.531	2.866	3.303	3.468						

						 100-39*½												
						400023												
0,8	99	11	14,5	'	10%		2.744	2.839	3.038	3.297	3.395	3.855	4.283	5.268				
							Rivestimento / Replacement cover	1.373	1.507	1.705	1.964	2.062						

						 105-41*¾ 158-62*¾												
						400025												
1,27	90	11,7	14,4	'	10%		3.228	3.340	3.574	3.877	3.993	4.535	5.040	6.198				
							Rivestimento / Replacement cover	1.615	1.771	2.006	2.309	2.426						

I prezzi sono espressi in Euro
Prices are in Euro

Consultare condizione di vendita e avvertenze importanti
Please check our sale conditions and important remarks

400-Senza_Tempo

design Gianluigi Landoni

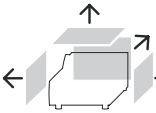
M ³	Kg.	MI.	M ²			Tessuto - Fabric					Pelle - Leather			
Volume Volume	Peso Weight	Tessuto Fabric	Pelle Leather	Imballi legno Wood packaging	Prelavaggio p. 7/10 Prewash p. 7/10	 <p>Possibile su misura Special sizes available</p>	Tessuto cliente COM	D - F - Aqua	Extra	Super	Nature	Pelle cliente COL	Pelle	Pelle Lusso
<input type="checkbox"/> previsto (rif. tab. pag. 3) / available: s.table p.3 incluso / included														

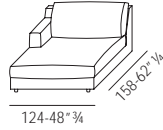

4000027



4000026

1,49	98	12,9	16,6	'	10%														
							Rivestimento / Replacement cover	1.682	1.846	2.089	2.405	2.526							
								3.362	3.478	3.722	4.038	4.160	4.724	5.250	6.457				

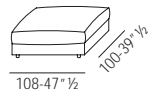

4000028

0,5	40	6	9,5	'	10%														
							Rivestimento / Replacement cover	785	861	975	1.123	1.179							
								1.568	1.622	1.736	1.884	1.940	2.204	2.449	3.012				

<p><i>Il totale delle composizioni potrà non corrispondere a causa di arrotondamenti automatici.</i></p> <p><i>The total amount in compositions may not correspond to the sum of single prices due to automatic rounding.</i></p>	Q.tà / Qty / Q.té / Stk	Tessuto - Fabric					Pelle - Leather		
		Tessuto cliente COM	D - F - Aqua	Extra	Super	Nature	Pelle cliente COL	Pelle	Pelle Lusso

1

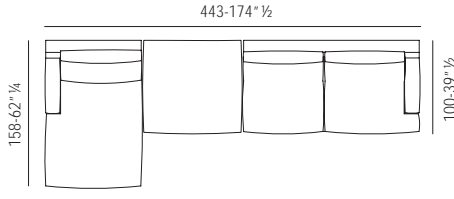

400019	1	3.688	3.819	4.089	4.439	4.572	5.207	5.786	7.121
400028	1	1.568	1.622	1.736	1.884	1.940	2.204	2.449	3.012
400025	1	3.228	3.340	3.574	3.877	3.993	4.535	5.040	6.198
Totale / Total		8.482	8.778	9.396	10.199	10.503	11.946	13.274	16.330

2

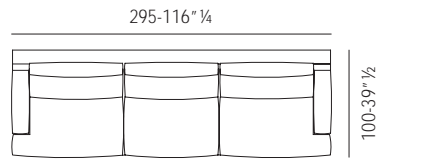

400004	1	5.016	5.198	5.564	6.042	6.222	7.097	7.887	9.700
Totale / Total		5.016	5.198	5.564	6.042	6.222	7.097	7.887	9.700

3

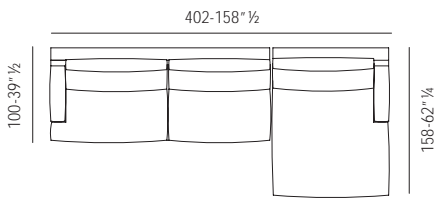

400020	1	3.688	3.819	4.089	4.439	4.572	5.207	5.786	7.121
400026	1	3.362	3.478	3.722	4.038	4.160	4.724	5.250	6.457
Totale / Total		7.049	7.295	7.809	8.477	8.731	9.931	11.035	13.578

4

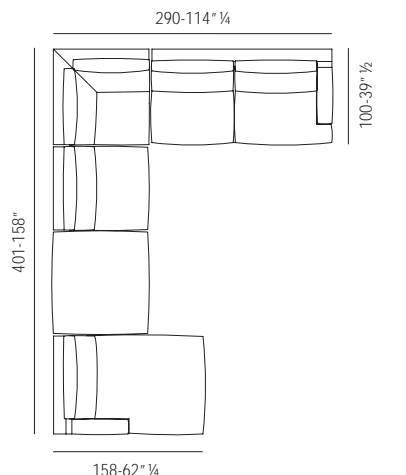

400017	1	3.459	3.581	3.833	4.161	4.287	4.885	5.428	6.661
400023	1	2.744	2.839	3.038	3.297	3.395	3.855	4.283	5.268
400005	1	1.821	1.890	2.044	2.247	2.314	2.618	2.909	3.576
400028	1	1.568	1.622	1.736	1.884	1.940	2.204	2.449	3.012
400025	1	3.228	3.340	3.574	3.877	3.993	4.535	5.040	6.198
Totale / Total		12.813	13.268	14.221	15.461	15.924	18.095	20.107	24.714



Descrizione prodotto

Divani, poltrona bassa, poltrona alta senza e con braccioli, poltroncina pranzo, pouf, dormeuse

Caratteristiche tecniche

Divani

Struttura: legno multistrato e massello di abete

Basamento/piedi: noce Canaletto

Cuscino seduta: poliuretano espanso a quote differenziate, ricoperto in termolegato cotone 100%

Cuscini schienale: fibra di poliestere siliconata ricoperta da fodera cotone 100%

Imbottitura base/schienale: poliuretano espanso a quote differenziate ricoperto in termofalda

Finitura base: pelle a scelta

Rivestimento: rivestimento in pelle o in tessuto. Rivestimento in tessuto completamente sfoderabile

Poltrone

Struttura: legno multistrato e massello di abete

Basamento e piedi: noce Canaletto

Cuscino seduta: poliuretano espanso a quote differenziate, ricoperto in termolegato cotone 100%

Rullo: fibra di poliestere siliconata ricoperta da fodera cotone 100%

Finitura base e schienale: pelle a scelta

Rivestimento cuscino schienale e rullo: rivestimento pelle o in tessuto.

Rivestimento in tessuto completamente sfoderabile

Poltroncina pranzo

Struttura: acciaio

Basamento/gambe: noce canaletto o frassino tinto moka

Imbottitura: poliuretano schiumato a freddo rivestito in vellutino

Rivestimento: rivestimento in pelle o in tessuto. Rivestimento in tessuto completamente sfoderabile.

Description of the product

Sofas, low back armchair, high back armchair with/without arms, dining armchair, ottoman, dormeuse

Technical features

Sofas

Frame: composite wood and solid fir-wood

Base /legs finishing: Canaletto walnut

Seat cushion: polyurethane foam with different densities covered with heated bonded polyester fibre.

Back cushions: silicone polyester fibre covered with 100% cotton lining

Base/backrest padding: polyurethane foam with different densities

Base finishing: in leather according to choice

Cover: fabric or leather cover.

Fabric cover completely removable

Armchair

Frame: composite wood and solid fir-wood

Base /legs finishing: Canaletto walnut

Seat cushion: polyurethane foam with different densities covered with heated bonded polyester fibre.

Backrest roll: silicone polyester fibre covered with 100% cotton lining

Base/backrest finishing: in leather according to choice

Seat cushion/roll cover: fabric or leather cover.

Fabric completely removable

Dining armchair

Frame: steel

Base/legs finishing: Canaletto walnut or moka stained ash

Padding: cold foam polyurethane covered with velveetin

Cover: fabric or leather cover.

Fabric completely removable

Produktbeschreibung

Sofas, hoher Sessel mit o. ohne Armlehnen, niedriger Sessel, Esstischsessel, Hocker, Dormeuse

Technische Angaben

Sofas

Korpusgestell: Schichtholz und Fichtenholz massiv

Rahmen u. FuÙe: Canaletto Walnut

Sitzkissen: Aus Polyurethanschamstoff in verschiedenen Quoten mit Abdeckung aus thermisch gebundenen Fasern mit 100% Baumwollschicht

Rückenkissen: Silicon-Polyester-Fasern mit einem Bezug aus 100% Baumwolle

Gestell- und Rückenlehnpolsterung: Aus Polyurethanschamstoff in verschiedenen Quoten.

Finish des Gestells: Profil in Leder bezogen nach Wahl

Bezug: Bezug aus Stoff oder Leder.

Stoffbezug ganz abnehmbar

Sessel

Korpusgestell: Schichtholz und Fichtenholz massiv

Rahmen u. FuÙe: Canaletto Walnut

Sitzkissen: Aus Polyurethanschamstoff in verschiedenen Quoten mit Abdeckung aus thermisch gebundenen Fasern mit 100% Baumwollschicht

Rückenrolle: Silicon-Polyester-Fasern mit einem Bezug aus 100% Baumwolle

Finish des Gestells u. der Rückenlehne: Leder bezogen nach Wahl

Sitzkissen- u. Rückenrollenbezug: Bezug aus Stoff oder Leder.

Stoffbezug ganz abnehmbar

Esstischsessel

Gestell: Stahl

Rahmen u. FuÙe: Canaletto Walnuss oder mokkagebeizte Esche

Polsterung: Polyureththankaltschaum mit samtartigem Vlies

Bezug: Bezug aus Stoff oder Leder.

Stoffbezug ganzabnehmbar

Description du produit

Canapés, fauteuil bas, fauteuil haut sans/avec accoudoirs, petit fauteuil repas, pouf, dormeuse

Caractéristiques techniques

Canapés

Structure: bois massif multiplis et sapin massif

Finition piètement: bois noyer Canaletto

Coussin d'assise: mousse del polyuréthane de diferentes densités, enrobées en fibre thermomoullé recouverte de coton 100%

Coussins de dossier: fibre en polyester siliconée recouverte de coton 100%

Rembourrage base/dossier: mousse de polyuréthane de diferentes densités

Finition cadre: cuir au choix

Revêtement: revêtement en tissu ou en cuir.

Revêtement en tissu entièrement déhoussable

Fauteuil

Structure: bois massif multiplis et sapin massif

Finition piètement: bois noyer Canaletto

Coussin d'assise: mousse del polyuréthane de diferentes densités, enrobées en fibre thermomoullé recouverte de coton 100%

Rouleau appuie-reins: fibre en polyester siliconée recouverte de coton 100%

Finition base et dossier: cuir au choix

Appuie-reins: revêtement en tissu ou en cuir.

Revêtement en tissu entièrement déhoussable

Petit fauteuil repas

Structure: acier

Base et pieds: bois noyer Canaletto ou frêne teinté moka

Rembourrage: polyuréthane coulé à froid recouvert de garniture synthétique

Revêtement: revêtement en tissu ou en cuir.

Revêtement en tissu entièrement déhoussable

- A - Memory foam / Memory foam
- B - Espanso densità portante / Foam supporting density
- C - Espanso densità soft / Foam soft density
- L - Fusto in legno / Wooden frame
- R - Resinato / Heated bonded polyester fibre
- S - Fibra poliestere siliconata / Silicon polyester fibre

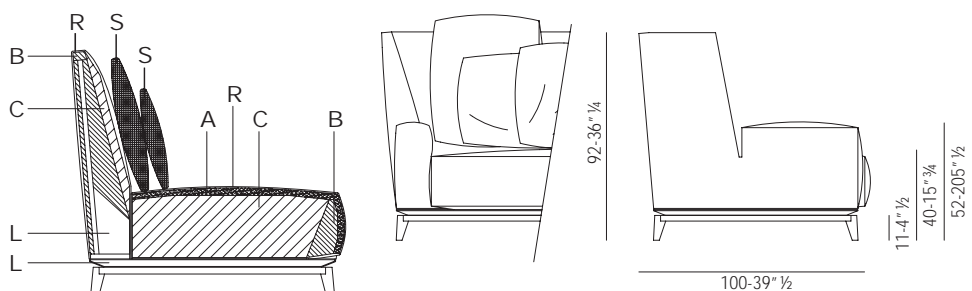

M ³	Kg.	MI.	M ²			Tessuto - Fabric					Pelle - Leather			
Volume Volume	Peso Weight	Tessuto Fabric	Pelle Leather	Imballi legno Wood packaging	Prelavaggio p. 7/10 Prewash p. 7/10	 <i>Possibile su misura</i> <i>Special sizes available</i>	Tessuto cliente COM	D - F - Aqua	Extra	Super	Nature	Pelle cliente COL	Pelle	Pelle Lusso
							<input type="radio"/> previsto (rif. tab. pag. 3) / available: s.table p.3 <input type="radio"/> incluso / included							

(*) (**) mt. a richiesta / on request

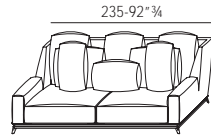

430001

2,4	145	19	29	'	+10%		7.396	7.533	7.794	8.179	8.424	8.313	9.237	11.154
						Rivestimento / Replacement cover	3.328	3.392	3.507	3.681	3.792			

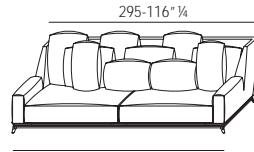

430002

3	165	21	35	'	+10%		8.064	8.214	8.498	8.921	9.189	9.066	10.073	12.167
						Rivestimento / Replacement cover	3.630	3.698	3.825	4.015	4.135			

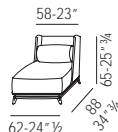

430004

0,44	35	3 (*)	(**)	'	+10%	schienale pelle/ leather back/ dossier en cuir/ Rückenlehne Leder	3.668	3.627	3.688	3.856	3.971	3.806	4.229	4.440
						Rivestimento / Replacement cover	523	570	632	800	823	1.005	1.117	1.317



430006

0,63	38	3 (*)	(**)	'	+10%	schienale pelle/ leather back/ dossier en cuir/ Rückenlehne Leder	3.758	3.715	3.777	3.941	4.059	3.891	4.323	4.538
						Rivestimento / Replacement cover	523	571	632	800	823	1.005	1.117	1.317

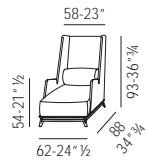

430013

0,63	38	3 (*)	(**)	'	+10%	schienale pelle/ leather back/ dossier en cuir/ Rückenlehne Leder	4.514	4.448	4.513	4.678	4.819	4.619	5.132	5.389
						Rivestimento / Replacement cover	523	570	632	800	823	1.005	1.117	1.317

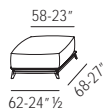

430015

0,2	24	2	2,5	'	+10%		1.982	1.991	2.053	2.209	2.276	2.061	2.290	2.404
						Rivestimento / Replacement cover	499	543	606	764	786	960	1.067	1.258

I prezzi sono espressi in Euro
Prices are in Euro

Consultare condizione di vendita e avvertenze importanti
Please check our sale conditions and important remarks

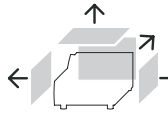
M ³	Kg.	MI.	M ²			Tessuto - Fabric					Pelle - Leather			
Volume Volume	Peso Weight	Tessuto Fabric	Pelle Leather	Imballi legno Wood packaging	Prelavaggio p. 7/10 Prewash p. 7/10	 <p>Possibile su misura Special sizes available</p>	Tessuto cliente COM	D - F - Aqua	Extra	Super	Nature	Pelle cliente COL	Pelle	Pelle Lusso
							<input type="checkbox"/> previsto (rif. tab. pag. 3) / available: s.table p.3 incluso / included							

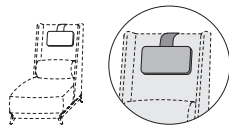

430007

0,04	2	0,6	0,6																
						Rivestimento / Replacement cover					191	190	207	234	242	285	316	379	
						Rivestimento / Replacement cover					111	114	131	158	163	220	244	308	

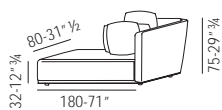

430020



430021

1,08	70	12	16	'	+10%															
						Rivestimento / Replacement cover					4.438	4.528	4.708	4.922	5.069	5.003	5.560	6.672		
						Rivestimento / Replacement cover					1.997	2.157	2.337	2.551	2.699					



Descrizione prodotto

Divani, Divani componibili, Chaise longue, Pouf, Poltrona

Caratteristiche tecniche

Struttura base: Metallo verniciato.

Struttura schienali/braccioli: Massello di abete.

Molleggio: Nastri elastici unidirezionali ad alta portata.

Imbottitura base e schienale: Poliuretano espanso ricoperto in termofalda.

Cuscini seduta: Inserto in poliuretano espanso avvolto da materassina in piuma.

Imbottitura bracciolo: Inserto in poliuretano espanso avvolto da materassina in piuma.

Piedi: Metallo brunito.

Finitura: Cordolo tessuto (vedi catalogo).

Rivestimento: Rivestimento in tessuto o in pelle. Rivestimento in tessuto completamente sfoderabile.

Accessorio: Cornice in noce canaletto.

Note particolari

Nelle composizioni è necessario il disegno. All'ordine specificare colore cordolo.

Description of the product

Sofas, Unit sofas, Chaise longue, Ottoman, Armchair

Technical features

Frame base: Painted metal.

Frame back/arm: Solid fir-wood.

Springing: High resistance unidirectional elastic bands.

Base and back padding: Polyurethane foam covered with heated bonded polyester fibre.

Seat cushions: Core in polyurethane foam covered with a feather layer.

Arm padding: Core in polyurethane foam covered with a feather layer.

Feet: Metal finishing burnished.

Finishing: Fabric piping (see catalog).

Cover: Fabric or leather cover. Fabric cover completely removable.

Accessory: Base in Canaletto walnut.

Special notes

For compositions, please supply the drawing.

Please specify piping colour on order.

Produktbeschreibung

Sofas, Anbauelemente, Chaise longue, Hocker, Sessel

Technische Angaben

Korpusgestell: Aus lackiertem Metall.

Gestell der Arm-/Rückenlehne: Aus massivem Fichtenholz.

Federung: Mit hochbelastbaren und unidirektionalen elastischen Gurten.

Gestell- und Rückenlehnepolsterung: Polyurethanschaumstoff mit thermisch gebundenen Fasern.

Sitzkissen: Polyurethanschaumstoffeinlage, Finish in Daune.

Armlehnepolsterung:

Polyurethanschaumstoffeinlage, Finish in Daune.

FüÙe: Brünirtes Metall.

Finish: Stoffkeder (s. Katalog).

Bezug: Bezug aus Stoff oder Leder.

Stoffbezug ganz abnehmbar.

Option: Rahmen in Canaletto WalnuÙ.

Bemerkungen

Im Falle von Kombinationen bitte Skizze beilegen.

Bei der Bestellung Kederfarbe angeben.

Description du produit

Canapés, Canapés modulables, Chaise longue, Pouf, Fauteuil

Caractéristiques techniques

Structure base: Métal verni.

Structure dossier/accoudoir: Sapin massif.

Suspension: Sangles élastiques unidirectionnelles à haute résistance.

Rembourrage base et dossier: Mousse de polyuréthane enrobée en fibre thermomoulée.

Coussins d'assise: Mousse de polyuréthane enrobée d'un matelas en plume.

Rembourrage accoudoir: Mousse de polyuréthane enrobée d'un matelas en plume.

Pieds: Métal bruni.

Finition: Passepoil en tissu (voir catalogue).

Revêtement: Revêtement en tissu ou en cuir.

Revêtement en tissu entièrement déhoussable.

Accessoire: Encadrement en bois noyer Canaletto.

Remarques

Pour les compositions un dessin est indispensable.

À la commande spécifier le coloris du passepoil.

- B - Espanso densità portante / Foam supporting density
- C - Espanso densità soft / Foam soft density
- F - Telaio in ferro / Iron frame
- L - Fusto in legno / Wooden frame
- P - Piuma / Feather
- R - Resinato / Heated bonded polyester fibre

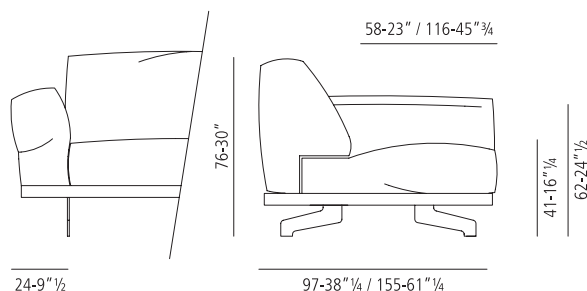
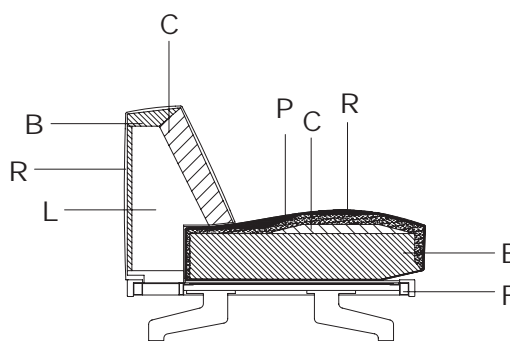

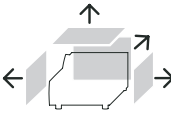
M ³	Kg.	MI.	M ²			Tessuto - Fabric					Pelle - Leather			
Volume Volume	Peso Weight	Tessuto Fabric	Pelle Leather	Imballi legno Wood packaging	Prelavaggio p. 7/10 Prewash p. 7/10	 <i>Possibile su misura</i> <i>Special sizes available</i>	Tessuto cliente COM	D - F - Aqua	Extra	Super	Nature	Pelle cliente COL	Pelle	Pelle Lusso
							<input type="radio"/> previsto (rif. tab. pag. 3) / available: s.table p.3 <input type="radio"/> incluso / included							



134-52*¾

470042

1,04	74	7,5	11,5	'	+10%		3.194	3.307	3.537	3.852	3.968	4.221	4.690	5.751
						Base / Rahmen Canaletto	162							
						Rivestimento / Replacement cover	1.228	1.377	1.591	1.897	1.955			



216-85*¾

470020

1,76	130	12,4	17	'	+10%		4.295	4.423	4.690	5.061	5.213	5.496	6.106	7.447
						Base / Rahmen Canaletto	226							
						Rivestimento / Replacement cover	1.745	1.949	2.213	2.610	2.689			



256-101*

470021

2,08	138	12,4	20	'	+10%		4.677	4.817	5.104	5.506	5.673	5.982	6.646	8.106
						Base / Rahmen Canaletto	259							
						Rivestimento / Replacement cover	1.976	2.198	2.481	2.916	3.002			



168-66*¾

470022

1,38	92	9,6	12,6	'	+10%		3.291	3.352	3.493	3.680	3.791	3.885	4.317	5.188
						Base / Rahmen Canaletto	195							
						Rivestimento / Replacement cover	1.306	1.427	1.574	1.785	1.840			



192-75*¾

470025



470024

1,54	111	11	14,8	'	+10%		3.794	3.891	4.093	4.371	4.502	4.687	5.208	6.313
						Base / Rahmen Canaletto	213							
						Rivestimento / Replacement cover	1.527	1.689	1.894	2.200	2.267			

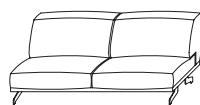

208-82*

470023

1,7	100	9,6	15,6	'	+10%		3.663	3.735	3.900	4.120	4.245	4.359	4.843	5.829
						Base / Rahmen Canaletto	226							
						Rivestimento / Replacement cover	1.527	1.689	1.894	2.200	2.267			

I prezzi sono espressi in Euro
Prices are in Euro

Consultare condizione di vendita e avvertenze importanti
Please check our sale conditions and important remarks

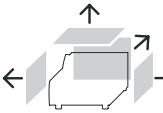
M ³	Kg.	MI.	M ²			Tessuto - Fabric					Pelle - Leather		
Volume Volume	Peso Weight	Tessuto Fabric	Pelle Leather	Imballi legno Wood packaging	Prelavaggio p. 7/10 Prewash p. 7/10								
 <p>Possibile su misura Special sizes available</p>						Tessuto cliente COM	D - F - Aqua	Extra	Super	Nature	Pelle cliente COL	Pelle	Pelle Lusso
						<input type="radio"/> previsto (rif. tab. pag. 3) / available: s.table p.3 incluso / included							



232-91* 1/2

470027

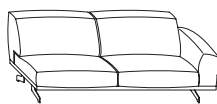

470026

1,89	119	11	17,8	'	+10%		4.170	4.276	4.502	4.817	4.962	5.168	5.742	6.965
						Base / Rahmen Canaletto	244							
						Rivestimento / Replacement cover	1.758	1.935	2.164	2.502	2.576			



228-90*

470033

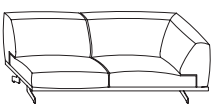

470032

1,86	137	11,5	19	'	+10%		4.323	4.436	4.677	5.014	5.165	5.394	5.994	7.279
						Base / Rahmen Canaletto	244							
						Rivestimento / Replacement cover	1.785	1.972	2.210	2.572	2.649			

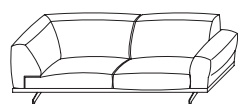

252-99* 1/2

470034

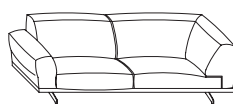

470035

2,08	156	13,1	21,2	'	+10%		4.826	4.976	5.278	5.706	5.878	6.206	6.895	8.420
						Base / Rahmen Canaletto	259							
						Rivestimento / Replacement cover	2.006	2.231	2.530	2.979	3.069			



110-43* 1/2

470037



155-61* 1/2

470036

1,47	112	8,5	12,5	'	+10%		3.733	3.849	4.079	4.405	4.537	4.780	5.311	6.480
						Base / Rahmen Canaletto	195							
						Rivestimento / Replacement cover	1.448	1.626	1.858	2.203	2.270			



97-38* 1/2

470043

97
38* 1/2

0,45	44	3,5	5	'	+10%		1.808	1.872	1.994	2.170	2.234	2.396	2.662	3.247
						Base / Rahmen Canaletto	115							
						Rivestimento / Replacement cover	662	759	891	1.116	1.149			

<p><i>Il totale delle composizioni potrà non corrispondere a causa di arrotondamenti automatici.</i></p> <p><i>The total amount in compositions may not correspond to the sum of single prices due to automatic rounding.</i></p>	Q.ta / Qty / Q.té / Stk	Tessuto - Fabric					Pelle - Leather		
		Tessuto cliente COM	D - F - Aqua	Extra	Super	Nature	Pelle cliente COL	Pelle	Pelle Lusso

	470025	1	3.794	3.891	4.093	4.371	4.502	4.687	5.208	6.313
	470036	1	3.733	3.849	4.079	4.405	4.537	4.780	5.311	6.480
1	Totale / Total		7.526	7.738	8.169	8.774	9.037	9.467	10.519	12.791

	470037	1	3.733	3.849	4.079	4.405	4.537	4.780	5.311	6.480
	470022	1	3.291	3.352	3.493	3.680	3.791	3.885	4.317	5.188
	470036	1	3.733	3.849	4.079	4.405	4.537	4.780	5.311	6.480
2	Totale / Total		10.757	11.046	11.648	12.486	12.861	13.442	14.937	18.146

	470026	1	4.170	4.276	4.502	4.817	4.962	5.168	5.742	6.965
	470035	1	4.826	4.976	5.278	5.706	5.878	6.206	6.895	8.420
3	Totale / Total		8.993	9.252	9.776	10.521	10.838	11.373	12.636	15.384

	470037	1	3.733	3.849	4.079	4.405	4.537	4.780	5.311	6.480
	470036	1	3.733	3.849	4.079	4.405	4.537	4.780	5.311	6.480
4	Totale / Total		7.466	7.696	8.158	8.809	9.072	9.558	10.621	12.960

I prezzi sono espressi in Euro
Prices are in Euro

Consultare condizione di vendita e avvertenze importanti
Please check our sale conditions and important remarks

**Descrizione prodotto**

Poltrone, divani, divani componibili, terminali, chaise longue, pouf, contenitore

Caratteristiche tecniche

Struttura: Massello di abete e legno multistrato.

Molleggio: Nastri elastici unidirezionali ad alta portata.

Imbottitura: Poliuretano espanso.

Cuscini seduta: Poliuretano espanso a quote differenziate e memory ricoperto in termolegato cotone 100%.

Cuscini schienale: Piuma lavata e sterilizzata.

Piedi: Metallo brunito.

Rivestimento: Rivestimento in tessuto o in pelle. Rivestimento in tessuto completamente sfoderabile.

Contenitore: Legno laccato opaco (colori RAL a catalogo).

Accessorio: Poggiatesta in tubolare di ferro verniciato con cuscino in fibra poliestere siliconata ricoperta da fodera in cotone 100%.

Note particolari

Nelle composizioni è necessario il disegno. Alla consegna i piedi sono smontati.

Description of the product

Armchair, sofas, unit sofas, end elements, chaise longue, ottoman, container

Technical features

Frame: solid fir-wood and multilayer.

Springing: High resistance unidirectional elastic bands.

Padding: Polyurethane foam.

Seat cushions: Polyurethane foam with different densities and memory covered with heated bonded polyester fibre.

Back cushions: Sterilized and washed feather

Feet: Metal finishing burnished.

Cover: Fabric or leather cover.

Fabric cover completely removable.

Container: Matt lacquered wood (see catalog).

Accessory: Headrest in lacquered iron tubes with cushion in silicone polyester fibre covered with 100% cotton lining.

Special notes

For compositions, please supply the drawing.

Sofas are delivered with disassembled feet.

Produktbeschreibung

Sessel, Sofas, Anbauelemente, Schlusselemente, Hocker, Behälter

Technische Angaben

Gestell: Aus massivem Fichtenholz und Schichtholz

Federung: Mit hochbelastbaren und unidirektionalen elastischen Gurten.

Polsterung: Polyurethanschaumstoff.

Sitzkissen: Polyurethanschaumstoff in verschiedenen Quoten und Memory mit thermisch gebundenen Fasern mit 100% Baumwollbezug.

Rückenkissen: Vorgewaschene und sterilisierte Daune.

FüÙe: Brünirtes Metall.

Bezug: Bezug aus Stoff oder Leder.

Stoffbezug ganz abnehmbar.

Behälter: Mattlackiertes Holz (lt. RAL Farben).

Zubehör: Lackierte Eisenrohrkopfstütze mit Kissen in Silikon-Polyester-Fasern mit einem Bezug aus 100% Baumwolle.

Bemerkungen

Im Falle von Kombinationen bitte Skizze beilegen. Bei der Lieferung Sind die FüÙe nicht montiert.

Description du produit

Fauteuil, canapés, canapés modulaires, éléments terminaux, chaise longue, pouf, coffre

Caractéristiques techniques

Structure: Sapin massif et multiplis.

Suspension: Sangles élastiques unidirectionnelles á haute résistance.

Rembourrage: Mousse de polyuréthane.

Coussins d'assise: Mousse de polyuréthane de différentes densités et memory, enrobée en fibre thermomoullée recouverte de coton 100%.

Coussins de dossier: Plume lavée et stérilisée.

Pieds: Métal bruni.

Revêtement: Revêtement en tissu ou en cuir.

Revêtement en tissu entièrement déhoussable.

Coffre: En bois laqué mat (voir catalogue).

Accessoire: Appuie-tête en tubulaire en fer verni avec coussin en fibre en polyester siliconé recouverte de coton 100%.

Remarques

Pour les compositions un dessin est indispensable. A la livraison les pieds sont démontés.

A - Memory foam / Memory foam

B - Espanso densità portante / Foam supporting density

C - Espanso densità soft / Foam soft density

L - Fusto in legno / Wooden frame

P - Piuma / Feather

R - Resinato / Heated bonded polyester fibre

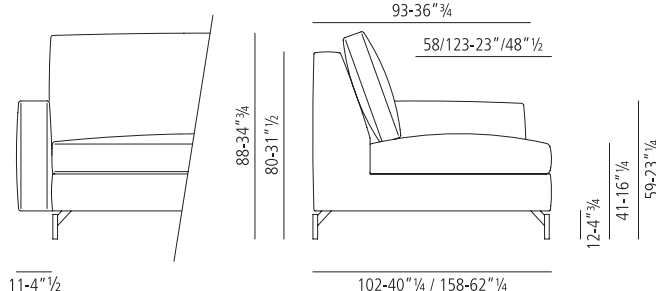
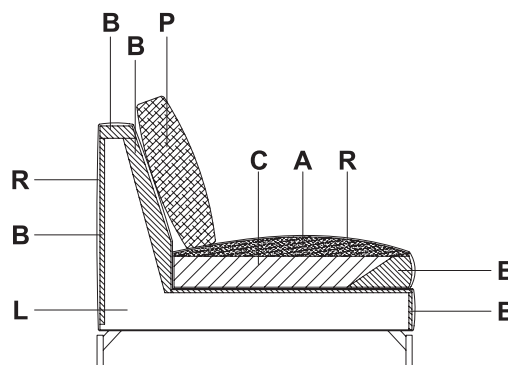

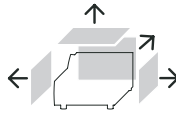
M ³	Kg.	MI.	M ²			 <i>Possibile su misura</i> <i>Special sizes available</i>	Tessuto - Fabric					Pelle - Leather		
Volume Volume	Peso Weight	Tessuto Fabric	Pelle Leather	Imballi legno Wood packaging	Prelavaggio p. 7/10 Prewash p. 7/10		<input type="radio"/> previsto (rif. tab. pag. 3) / available: s.table p.3 <input type="radio"/> incluso / included	Tessuto cliente COM	D - F - Aqua	Extra	Super	Nature	Pelle cliente COL	Pelle



0,06 3 1,5 2 ' +10%						525000								
						Rivestimento / Replacement cover	364	370	384	407	420	377	417	494
							225	226	231	244	251			



0,62 27 7 8 ' +10%						525001								
						Rivestimento / Replacement cover	1.859	1.898	1.992	2.137	2.201	2.709	3.009	3.487
							839	855	897	964	991			

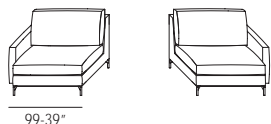

0,7 34 9 10 ' +10%						525003	525002							
						Rivestimento / Replacement cover	2.331	2.377	2.492	2.671	2.751	3.322	3.691	4.253
							1.050	1.070	1.122	1.203	1.240			

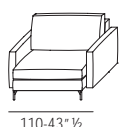

0,78 41 10,5 11,5 ' +10%						525004								
						Rivestimento / Replacement cover	2.803	2.858	2.990	3.202	3.299	3.933	4.370	5.022
							1.263	1.288	1.346	1.443	1.486			



0,76 30 7,5 9,6 ' +10%						525005								
						Rivestimento / Replacement cover	1.957	1.997	2.096	2.249	2.317	2.851	3.168	3.669
							881	900	944	1.013	1.043			

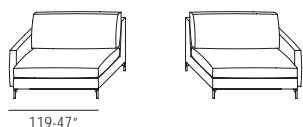

0,84 37 9 12 ' +10%						525007	525006							
						Rivestimento / Replacement cover	2.427	2.477	2.595	2.783	2.867	3.463	3.848	4.438
							1.095	1.117	1.169	1.254	1.292			

I prezzi sono espressi in Euro
Prices are in Euro

Consultare condizione di vendita e avvertenze importanti
Please check our sale conditions and important remarks

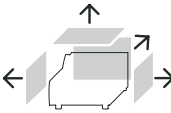
M ³	Kg.	MI.	M ²			 <i>Possibile su misura</i> <i>Special sizes available</i>	Tessuto - Fabric					Pelle - Leather		
Volume Volume	Peso Weight	Tessuto Fabric	Pelle Leather	Imballi legno Wood packaging	Prelavaggio p. 7/10 Prewash p. 7/10		<input type="radio"/> previsto (rif. tab. pag. 3) / available: s.table p.3 <input type="radio"/> incluso / included	Tessuto cliente COM	D - F - Aqua	Extra	Super	Nature	Pelle cliente COL	Pelle



130-51*¼

525008

0,92	44	10,5	13,5	'	+10%		2.901	2.955	3.094	3.315	3.416	4.076	4.529	5.207
Rivestimento / Replacement cover							1.306	1.331	1.395	1.494	1.539			



135-53*¼

525009

0,95	40	9	18	'	+10%		2.501	2.581	2.727	2.969	3.058	3.891	4.323	5.066
Rivestimento / Replacement cover							1.127	1.161	1.229	1.336	1.376			

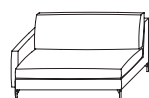

146-57*½

525011

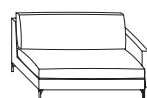

525010

1,03	47	10,5	20	'	+10%		2.975	3.059	3.228	3.501	3.605	4.504	5.004	5.832
Rivestimento / Replacement cover							1.339	1.377	1.455	1.576	1.623			



157-62"

525012

1,11	54	12,5	21,5	'	+10%		3.445	3.538	3.730	4.034	4.155	5.117	5.685	6.601
Rivestimento / Replacement cover							1.551	1.594	1.679	1.817	1.873			

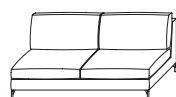

176-69*½

525013

1,23	54	13	22,5	'	+10%		2.876	2.967	3.139	3.414	3.515	4.474	4.972	5.824
Rivestimento / Replacement cover							1.295	1.336	1.413	1.538	1.583			

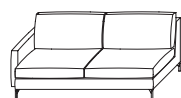

187-73*¾

525015

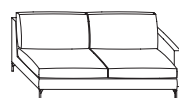

525014

1,31	61	15	24,5	'	+10%		3.349	3.446	3.639	3.946	4.065	5.087	5.652	6.592
Rivestimento / Replacement cover							1.508	1.552	1.638	1.776	1.830			

I prezzi sono espressi in Euro
Prices are in Euro

Consultare condizione di vendita e avvertenze importanti
Please check our sale conditions and important remarks

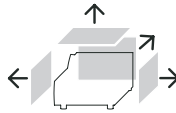
M ³	Kg.	MI.	M ²			Tessuto - Fabric					Pelle - Leather		
Volume Volume	Peso Weight	Tessuto Fabric	Pelle Leather	Imballi legno Wood packaging	Prelavaggio p. 7/10 Prewash p. 7/10						Pelle cliente COL	Pelle	Pelle Lusso
 <p>Possibile su misura Special sizes available</p>						Tessuto cliente COM	D - F - Aqua	Extra	Super	Nature			
						<input type="radio"/> previsto (rif. tab. pag. 3) / available: s.table p.3 incluso / included							

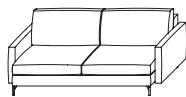

198-78"

525016

1,4	68	16,5	26	'	+10%		3.820	3.924	4.138	4.478	4.615	5.700	6.333	7.358
						Rivestimento / Replacement cover	1.721	1.768	1.862	2.017	2.077			

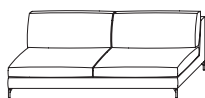

216-85" ¼

525017

1,51	60	14	27,5	'	+10%		3.126	3.224	3.409	3.708	3.820	4.864	5.404	6.330
						Rivestimento / Replacement cover	1.408	1.451	1.538	1.671	1.720			

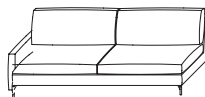

227-89" ½

525019

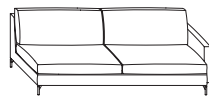

525018

1,59	67	15,7	29,5	'	+10%		3.596	3.702	3.909	4.243	4.371	5.476	6.085	7.098
						Rivestimento / Replacement cover	1.621	1.668	1.763	1.910	1.967			

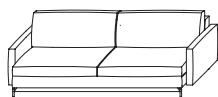

238-93" ¾

525020

1,67	74	17,2	31,4	'	+10%		4.071	4.182	4.409	4.774	4.917	6.089	6.765	7.866
						Rivestimento / Replacement cover	1.831	1.883	1.986	2.150	2.215			

Elemento terminale dx / sx
End element right / left

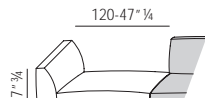

120-47" ¼

70-27" ¾

146-57" ½

525021

0,98	34	7	14,2	'	+10%		2.101	2.122	2.200	2.323	2.394	3.015	3.350	3.829
						Rivestimento / Replacement cover	949	956	990	1.047	1.078			



102-40" ¼

102-40" ¼

525023

0,80	70	10,4	14,5	'	+10%		2.891	2.997	3.192	3.474	3.578	3.949	4.388	5.354
						Rivestimento / Replacement cover	1.303	1.348	1.438	1.564	1.611			

I prezzi sono espressi in Euro
Prices are in Euro

Consultare condizione di vendita e avvertenze importanti
Please check our sale conditions and important remarks

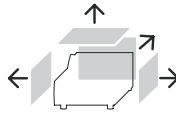
M ³	Kg.	MI.	M ²			Tessuto - Fabric					Pelle - Leather			
Volume Volume	Peso Weight	Tessuto Fabric	Pelle Leather	Imballi legno Wood packaging	Prelavaggio p. 7/10 Prewash p. 7/10	 <i>Possibile su misura</i> <i>Special sizes available</i>	Tessuto cliente COM	D - F - Aqua	Extra	Super	Nature	Pelle cliente COL	Pelle	Pelle Lusso
							<input type="radio"/> previsto (rif. tab. pag. 3) / available: s.table p.3 <input type="radio"/> incluso / included							

Terminale angolo dx / sx - Corner end element right / left

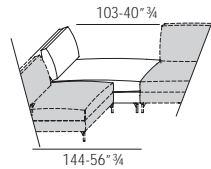

1,02	38	8,5	16,5	'	+10%	525024		2.401	2.449	2.566	2.751	2.833	3.419	3.799	4.383
						Rivestimento / Replacement cover		1.094	1.115	1.168	1.253	1.291			



1,23	38	10	18,5	'	+10%	525026		2.602	2.659	2.789	2.997	3.087	3.677	4.085	4.708
						Rivestimento / Replacement cover		1.174	1.198	1.256	1.348	1.390			

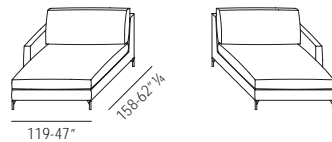

1,37	45	11	20,5	'	+10%	525028	525027	3.074	3.139	3.289	3.528	3.634	4.290	4.767	5.479
						Rivestimento / Replacement cover		1.384	1.413	1.481	1.591	1.638			

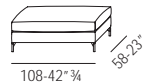

0,26	14	4	7	'	+10%	525030		1.231	1.246	1.293	1.371	1.413	1.579	1.755	1.986
						Rivestimento / Replacement cover		556	562	583	618	637			

M ³	Kg.													
Volume Volume	Peso Weight	Imballi legno Wood packaging												

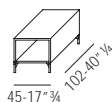

0,25	10	'				525033		1.144							
------	----	---	--	--	--	--------	--	-------	--	--	--	--	--	--	--

I prezzi sono espressi in Euro
Prices are in Euro

Consultare condizione di vendita e avvertenze importanti
Please check our sale conditions and important remarks

<p><i>Il totale delle composizioni potrà non corrispondere a causa di arrotondamenti automatici.</i></p> <p><i>The total amount in compositions may not correspond to the sum of single prices due to automatic rounding.</i></p>	Q.ta / Qty / Q.té / Stk	Tessuto - Fabric					Pelle - Leather		
		Tessuto cliente COM	D - F - Aqua	Extra	Super	Nature	Pelle cliente COL	Pelle	Pelle Lusso

1	292-115"		146-57" ½		146-57" ½				
			102-40" ¼						
525011	1	2.975	3.059	3.228	3.501	3.605	4.504	5.004	5.832
525010	1	2.975	3.059	3.228	3.501	3.605	4.504	5.004	5.832
Totale / Total		5.948	6.117	6.453	7.001	7.211	9.006	10.009	11.665

2	238-93" ¾		119-47"		119-47"				
			102-40" ¼			158-62" ¼			
525007	1	2.427	2.477	2.595	2.783	2.867	3.463	3.848	4.438
525027	1	3.074	3.139	3.289	3.528	3.634	4.290	4.767	5.479
Totale / Total		5.499	5.614	5.881	6.311	6.500	7.752	8.612	9.916

3	398-156" ¾		119-47"		135-53" ¼		144-56" ¾			
			108-42" ¾			102-40" ¼			248-97" ¾	
525000	1	364	370	384	407	420	377	417	494	
525007	1	2.427	2.477	2.595	2.783	2.867	3.463	3.848	4.438	
525009	1	2.501	2.581	2.727	2.969	3.058	3.891	4.323	5.066	
525024	1	2.401	2.449	2.566	2.751	2.833	3.419	3.799	4.383	
525010	1	2.975	3.059	3.228	3.501	3.605	4.504	5.004	5.832	
525030	1	1.231	1.246	1.293	1.371	1.413	1.579	1.755	1.986	
Totale / Total		11.890	12.170	12.785	13.774	14.187	17.227	19.141	22.193	

4	383-151"		102-40" ¼		135-53" ¼		146-57" ½			
			290-114" ¼			144-56" ¾			102-40" ¼	
525011	1	2.975	3.059	3.228	3.501	3.605	4.504	5.004	5.832	
525024	1	2.401	2.449	2.566	2.751	2.833	3.419	3.799	4.383	
525009	1	2.501	2.581	2.727	2.969	3.058	3.891	4.323	5.066	
525021	1	2.101	2.122	2.200	2.323	2.394	3.015	3.350	3.829	
Totale / Total		9.973	10.204	10.717	11.539	11.885	14.826	16.473	19.107	

I prezzi sono espressi in Euro
Prices are in Euro

Consultare condizione di vendita e avvertenze importanti
Please check our sale conditions and important remarks

**Descrizione prodotto**

Divani, Divani componibili, Chaises longues, Pouf

Caratteristiche tecniche

Struttura base: Metallo verniciato a polvere epossidica.

Struttura schienale/bracciolo/terminale angolo: Legni composti.

Molleggio: Nastri elastici unidirezionali ad alta portata.

Imbottitura schienale/bracciolo/term. angolo: Poliuretano espanso a quote differenziate, ricoperto in termofalda.

Cuscino seduta: Poliuretano espanso a quote differenziate con **memory foam**, ricoperto in termofalda.

Meccanismo seduta: Reclinabile in 5 posizioni.

Tavolino: Piano rivestito in cuoio (vedi catalogo).

Piedi: Metallo verniciato nero.

Rivestimento: Rivestimento in tessuto o in pelle. Rivestimento in tessuto completamente sfoderabile.

Note particolari

Nelle composizioni è necessario il disegno.

Description of the product

Sofas, Unit sofas, Chaises longues, Ottoman

Technical features

Frame base: Epoxy powder coated metal.

Back/arm/corner end element frame: Composite woods.

Springing: High resistance unidirectional elastic bands.

Back/arm/corner end element padding: Polyurethane foam with different densities covered with heated bonded polyester fibre.

Seat cushion: Polyurethane foam with different densities with **memory foam** covered with heated bonded polyester fibre.

Seat mechanism: Adjustable in 5 positions.

Small table: top with emery leather (see catalog).

Feet: dyed black metal.

Cover: Fabric or leather cover.

Fabric cover completely removable.

Special notes

For compositions, please supply the drawing.

Produktbeschreibung

Sofas, Anbauelemente, Chaises Longues, Hocker

Technische Angaben

Korpusgestell: Mit Epoxypulver lackiertes Metall.

Gestell der Rücken- und Armlehne und des

Eckschlußteils: Holzagglomerat.

Federung: Mit hochbelastbaren und unidirektionalen elastischen Gurten.

Polsterung der Rücken- und Armlehne und des Eckschlußteils: Polyurethanschaumstoff in verschiedenen Schichten mit thermisch gebundenen Fasern.

Sitzkissen: Polyurethanschaumstoff in verschiedenen Schichten mit **memory foam** mit thermisch gebundenen Fasern.

Sitzmechanismus: In 5 verschiedenen Positionen klappbar.

Ablage: Oberfläche in Kernleder bezogen (s. Katalog)

FüÙe: Schwarzlackiertes Metall.

Bezug: Bezug aus Stoff oder Leder.

Stoffbezug ganz abnehmbar.

Bemerkungen

Im Falle von Kombinationen bitte Skizze beilegen.

Description du produit

Canapés, Canapés modulables, Chaises longues, Pouf

Caractéristiques techniques

Structure base: Métal peint à poudre époxy.

Structure dossier/ accoudoir/élément terminal angle: Aggloméré de bois.

Suspension: Sangles élastiques unidirectionnelles à haute résistance.

Rembouillage dossier/accoudoir/élément

Terminal angle: Mousse de polyuréthane de différents densités enrobée en fibre thermomoulée.

Coussin assise: Mousse de polyuréthane de différents densités et **memory foam** enrobée en fibre thermomoulée.

Mécanisme assise: Inclination en 5 positions.

Table: plateau recouvert en cuir (voir catalogue).

Pieds: Métal teinté en noir.

Revêtement: Revêtement en tissu ou en cuir.

Revêtement en tissu entièrement déhoussable.

Remarques

Pour les compositions un dessin est indispensable.

- A - Memory foam / Memory foam
 B - Espanso densità portante / Foam supporting density
 C - Espanso densità soft / Foam soft density
 F - Telaio in ferro / Iron frame
 L - Fusto in legno / Wooden frame
 R - Resinato / Heated bonded polyester fibre

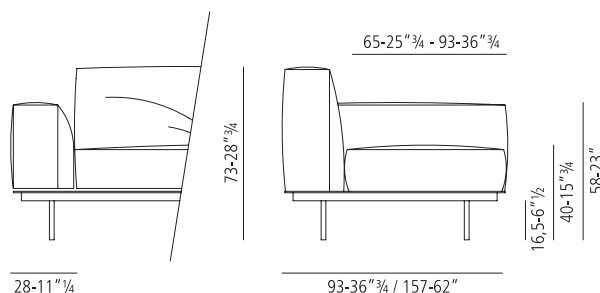
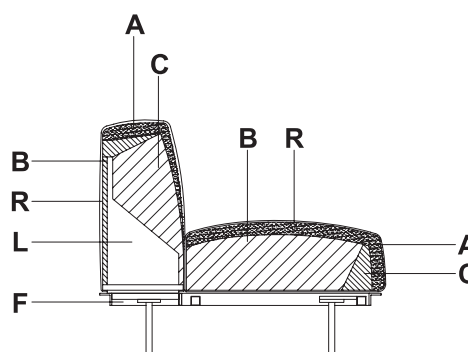

535-Sit Up design Tomu Katayanagi

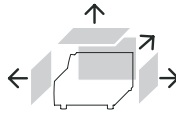
M ³	Kg.	MI.	M ²			Tessuto - Fabric					Pelle - Leather			
Volume Volume	Peso Weight	Tessuto Fabric	Pelle Leather	Imballi legno Wood packaging	Prelavaggio p. 7/10 Prewash p. 7/10	 <p>Possibile su misura Special sizes available</p>	Tessuto cliente COM	D - F - Aqua	Extra	Super	Nature	Pelle cliente COL	Pelle	Pelle Lusso
					<input type="radio"/> previsto (rif. tab. pag. 3) / available: s.table p.3 <input type="radio"/> incluso / included									

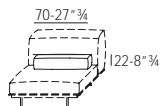

0,015	3	0,9	1,3		+10%	535064									
							Rivestimento / Replacement cover	286	298	322	361	371	416	462	563
								138	156	178	218	223	290	337	437



0,04	4	0,9	1,5		+10%	535065									
							Rivestimento / Replacement cover	229	235	249	289	297	317	352	422
								158	158	171	210	215	248	282	341

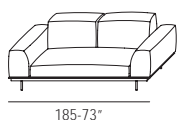

1,08	103	7,5	12,5	'	+10%	535001									
							Rivestimento / Replacement cover	3.800	3.879	4.073	4.357	4.489	4.610	5.122	6.042
								1.510	1.656	1.855	2.168	2.234			

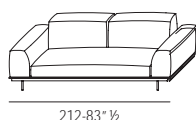

1,24	112	8,5	13,5	'	+10%	535002									
							Rivestimento / Replacement cover	3.983	4.063	4.266	4.564	4.700	4.827	5.363	6.329
								1.581	1.734	1.942	2.271	2.338			

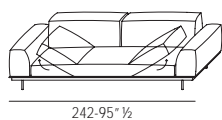

1,41	121	9	14,5	'	+10%	535003									
							Rivestimento / Replacement cover	4.260	4.341	4.552	4.863	5.010	5.122	5.691	6.701
								1.657	1.816	2.036	2.377	2.449			

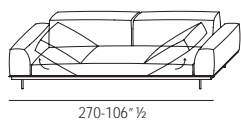

1,57	130	10	16	'	+10%	535004									
							Rivestimento / Replacement cover	4.460	4.545	4.768	5.089	5.242	5.362	5.958	7.014
								1.736	1.904	2.134	2.490	2.565			

I prezzi sono espressi in Euro
Prices are in Euro

Consultare condizione di vendita e avvertenze importanti
Please check our sale conditions and important remarks

535-Sit Up design Tomu Katayanagi

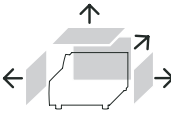
M ³	Kg.	MI.	M ²			Tessuto - Fabric					Pelle - Leather			
Volume Volume	Peso Weight	Tessuto Fabric	Pelle Leather	Imballi legno Wood packaging	Prelavaggio p. 7/10 Prewash p. 7/10	 <i>Possibile su misura</i> <i>Special sizes available</i>	Tessuto cliente COM	D - F - Aqua	Extra	Super	Nature	Pelle cliente COL	Pelle	Pelle Lusso
							<input type="radio"/> previsto (rif. tab. pag. 3) / available: s.table p.3 <input type="radio"/> incluso / included							

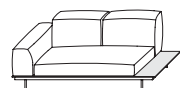

185-73"

535006

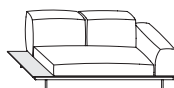

535005

1,08	98	6	11	'	+10%		3.757	3.836	4.030	4.313	4.440	4.588	5.091	6.010
						Rivestimento / Replacement cover	1.320	1.448	1.623	1.896	1.954			

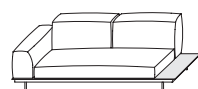

212-83" 1/2

535008

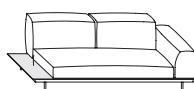

535007

1,24	107	7	12	'	+10%		3.937	4.021	4.222	4.518	4.652	4.804	5.330	6.295
						Rivestimento / Replacement cover	1.393	1.526	1.710	1.999	2.058			

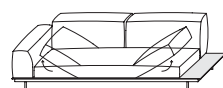

242-95" 1/2

535010

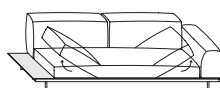

535009

1,41	116	7,5	13	'	+10%		4.213	4.298	4.508	4.820	4.964	5.099	5.658	6.669
						Rivestimento / Replacement cover	1.466	1.609	1.800	2.106	2.168			

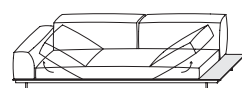

270-106" 1/2

535012

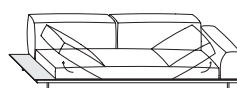

535011

1,57	125	8,5	14,5	'	+10%		4.415	4.503	4.723	5.048	5.197	5.340	5.926	6.982
						Rivestimento / Replacement cover	1.547	1.697	1.898	2.217	2.284			

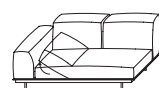

157-62"

535014

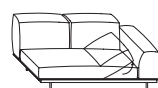

535013

0,92	91	6	11	'	+10%		3.373	3.434	3.604	3.851	3.966	4.061	4.513	5.319
						Rivestimento / Replacement cover	1.320	1.448	1.623	1.896	1.954			

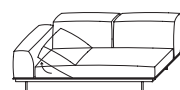

184-72" 1/2

535016

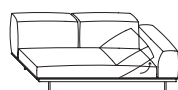

535015

1,08	97	7	12	'	+10%		3.550	3.619	3.797	4.059	4.180	4.280	4.756	5.605
						Rivestimento / Replacement cover	1.393	1.526	1.710	1.999	2.058			

I prezzi sono espressi in Euro
Prices are in Euro

Consultare condizione di vendita e avvertenze importanti
Please check our sale conditions and important remarks

535-Sit Up

design Tomu Katayanagi

M ³	Kg.	MI.	M ²			Tessuto - Fabric					Pelle - Leather			
Volume	Peso	Tessuto	Pelle	Imballi legno	Prelavaggio p. 7/10		Tessuto cliente	D - F - Aqua	Extra	Super	Nature	Pelle cliente	Pelle	Pelle Lusso
Volume	Weight	Fabric	Leather	Wood packaging	Prewash p. 7/10		COM					COL		
						<input type="radio"/> previsto (rif. tab. pag. 3) / available: s.table p.3 <input type="radio"/> incluso / included								

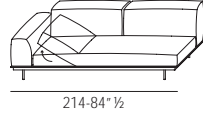

535018

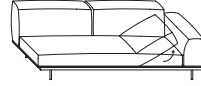

535017

1,25	109	7,5	13	'	+10%		3.739	3.812	3.998	4.271	4.399	4.506	5.006	5.901
						Rivestimento / Replacement cover	1.466	1.609	1.800	2.106	2.168			

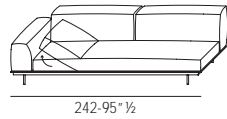

535020

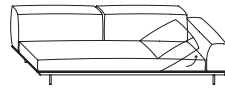

535019

1,41	117	8,5	14,5	'	+10%		3.938	4.015	4.213	4.500	4.634	4.746	5.274	6.217
						Rivestimento / Replacement cover	1.547	1.697	1.898	2.217	2.284			

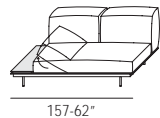

535022

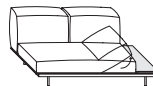

535021

0,92	86	4,5	9,5	'	+10%		3.322	3.393	3.559	3.810	3.921	4.040	4.481	5.288
						Rivestimento / Replacement cover	1.132	1.241	1.388	1.623	1.673			

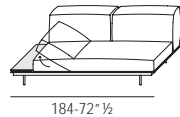

535024

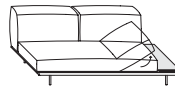

535023

1,08	92	5,5	10,5	'	+10%		3.506	3.575	3.753	4.014	4.132	4.258	4.723	5.572
						Rivestimento / Replacement cover	1.204	1.320	1.477	1.724	1.775			

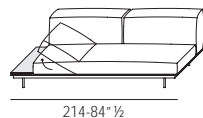

535026

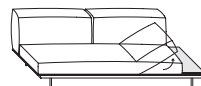

535025

1,25	104	6	11,5	'	+10%		3.695	3.767	3.953	4.230	4.355	4.484	4.975	5.869
						Rivestimento / Replacement cover	1.278	1.400	1.567	1.831	1.885			

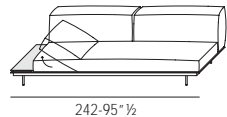

535028

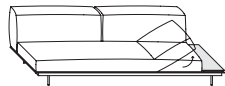

535027

1,41	112	7	13	'	+10%		3.895	3.974	4.169	4.459	4.590	4.724	5.242	6.184
						Rivestimento / Replacement cover	1.359	1.488	1.665	1.946	2.003			

I prezzi sono espressi in Euro
Prices are in Euro

Consultare condizione di vendita e avvertenze importanti
Please check our sale conditions and important remarks

535-Sit Up design Tomu Katayanagi

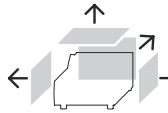
M ³	Kg.	MI.	M ²			Tessuto - Fabric					Pelle - Leather		
Volume Volume	Peso Weight	Tessuto Fabric	Pelle Leather	Imballi legno Wood packaging	Prelavaggio p. 7/10 Prewash p. 7/10								
 <p>Possibile su misura Special sizes available</p>						Tessuto cliente COM	D - F - Aqua	Extra	Super	Nature	Pelle cliente COL	Pelle	Pelle Lusso
						<input type="radio"/> previsto (rif. tab. pag. 3) / available: s.table p.3 incluso / included							

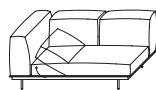

157-62"

535032

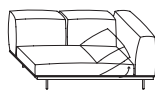

535031

0,92	93	7	12	'	+10%						3.599	3.670	3.854	4.116	4.239	4.342	4.825	5.684	
						Rivestimento / Replacement cover					1.412	1.549	1.734	2.028	2.088				

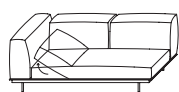

184-72" 1/2

535034

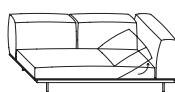

535033

1,08	99	8	13	'	+10%						3.780	3.854	4.045	4.323	4.453	4.559	5.065	5.972	
						Rivestimento / Replacement cover					1.484	1.628	1.822	2.130	2.195				

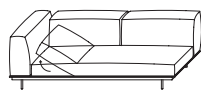

214-84" 1/2

535036

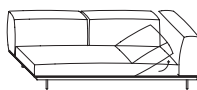

535035

1,25	111	8,5	14	'	+10%						3.967	4.045	4.246	4.537	4.672	4.787	5.318	6.268	
						Rivestimento / Replacement cover					1.560	1.710	1.914	2.237	2.304				

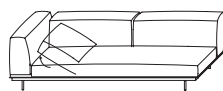

242-95" 1/2

535038

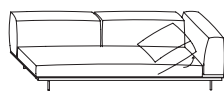

535037

1,41	119	9,5	15,5	'	+10%						4.170	4.251	4.460	4.765	4.907	5.027	5.586	6.581	
						Rivestimento / Replacement cover					1.639	1.798	2.011	2.350	2.419				

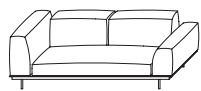

212-83" 1/2

535041

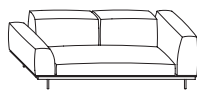

535042

1,24	116	9,5	14,5	'	+10%						4.214	4.298	4.513	4.825	4.970	5.107	5.674	6.694	
						Rivestimento / Replacement cover					1.673	1.835	2.055	2.399	2.471				

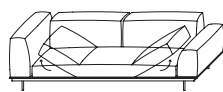

242-95" 1/2

535043

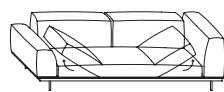

535044

1,41	125	10	15,5	'	+10%						4.488	4.575	4.804	5.126	5.280	5.401	6.001	7.066	
						Rivestimento / Replacement cover					1.747	1.919	2.146	2.509	2.584				

I prezzi sono espressi in Euro
Prices are in Euro

Consultare condizione di vendita e avvertenze importanti
Please check our sale conditions and important remarks

535-Sit Up

design Tomu Katayanagi

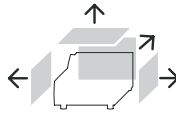
M ³	Kg.	MI.	M ²			Tessuto - Fabric					Pelle - Leather		
Volume Volume	Peso Weight	Tessuto Fabric	Pelle Leather	Imballi legno Wood packaging	Prelavaggio p. 7/10 Prewash p. 7/10						Pelle cliente COL	Pelle	Pelle Lusso
 <p>Possibile su misura Special sizes available</p>						Tessuto cliente COM	D - F - Aqua	Extra	Super	Nature			
						<input type="radio"/> previsto (rif. tab. pag. 3) / available: s.table p.3 incluso / included							

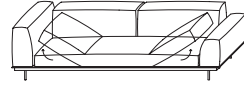

270-106* 1/2

535045

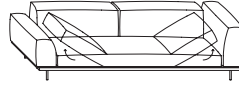

535046

1,57	134	11	17	'	+10%						4.686	4.780	5.014	5.353	5.514	5.640	6.268	7.382	
						Rivestimento / Replacement cover					1.828	2.006	2.247	2.622	2.701				

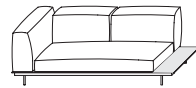

212-83* 1/2

535049

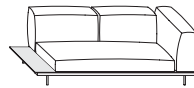

535050

1,24	110	8	13	'	+10%						4.169	4.253	4.468	4.782	4.924	5.084	5.640	6.663	
						Rivestimento / Replacement cover					1.484	1.628	1.822	2.130	2.195				

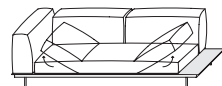

242-95* 1/2

535051

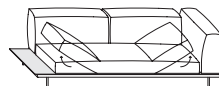

535052

1,41	119	8,5	14	'	+10%						4.445	4.533	4.754	5.086	5.235	5.379	5.970	7.033	
						Rivestimento / Replacement cover					1.560	1.710	1.914	2.237	2.304				

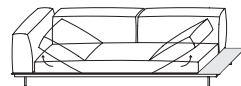

270-106* 1/2

535053

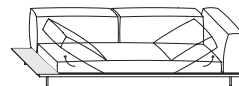

535054

1,57	128	9,5	15,5	'	+10%						4.645	4.738	4.972	5.312	5.469	5.621	6.237	7.349	
						Rivestimento / Replacement cover					1.639	1.798	2.011	2.350	2.419				

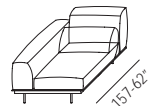

93-36* 3/4

535056

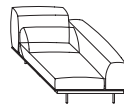

157-62

535055

0,92	91	5,5	9	'	+10%						3.092	3.152	3.307	3.454	3.557	3.641	4.045	4.765	
						Rivestimento / Replacement cover					1.212	1.328	1.486	1.658	1.709				



93-36* 3/4

535060

0,27	42	2,5	3,5	'	+10%						1.504	1.531	1.609	1.721	1.772	1.820	2.022	2.386	
						Rivestimento / Replacement cover					585	642	717	836	860				

I prezzi sono espressi in Euro
Prices are in Euro

Consultare condizione di vendita e avvertenze importanti
Please check our sale conditions and important remarks

Il totale delle composizioni potrà non corrispondere a causa di arrotondamenti automatici.

The total amount in compositions may not correspond to the sum of single prices due to automatic rounding.

Q.tà / Qty / Q.té / Stk	Tessuto - Fabric					Pelle - Leather		
	Tessuto cliente COM	D - F - Aqua	Extra	Super	Nature	Pelle cliente COL	Pelle	Pelle Lusso

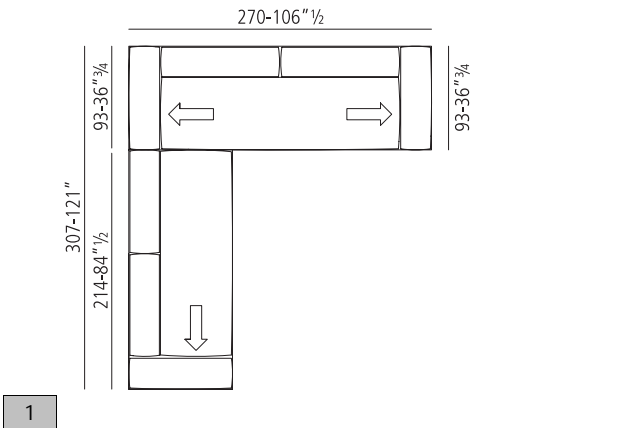

535045	1	4.686	4.780	5.014	5.353	5.514	5.640	6.268	7.382
535018	1	3.739	3.812	3.998	4.271	4.399	4.506	5.006	5.901
Totale / Total		8.424	8.590	9.012	9.623	9.912	10.146	11.273	13.282

1

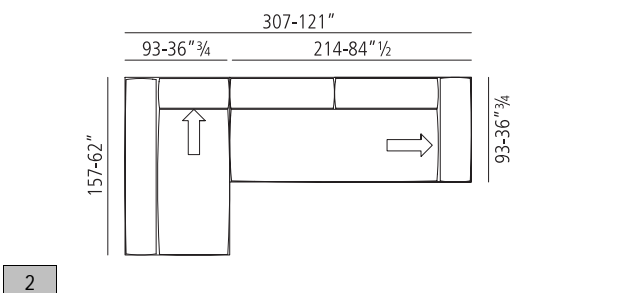

535056	1	3.092	3.152	3.307	3.454	3.557	3.641	4.045	4.765
535017	1	3.739	3.812	3.998	4.271	4.399	4.506	5.006	5.901
Totale / Total		6.829	6.962	7.305	7.723	7.955	8.146	9.050	10.666

2

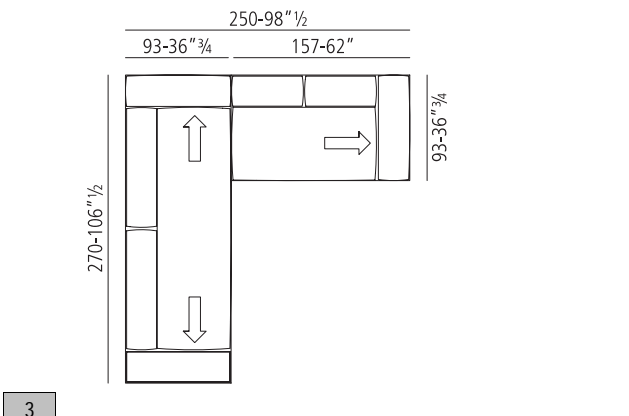

535054	1	4.571	4.667	4.900	5.242	5.399	5.551	6.168	7.279
535013	1	3.373	3.434	3.604	3.851	3.966	4.061	4.513	5.319
Totale / Total		7.942	8.101	8.502	9.090	9.363	9.611	10.680	12.597

3

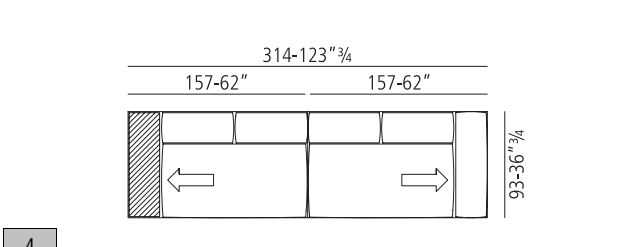

535022	1	3.322	3.393	3.559	3.810	3.921	4.040	4.481	5.288
535013	1	3.373	3.434	3.604	3.851	3.966	4.061	4.513	5.319
Totale / Total		6.693	6.827	7.161	7.659	7.886	8.101	8.993	10.606

4

**Descrizione prodotto**

Divani, Chaise longue, Pouf

Caratteristiche tecniche**Struttura base:** Metallo verniciato.**Struttura schienale:** Legno multistrato con meccanismo di apertura a catena continua.**Molleggio:** Nastri elastici unidirezionali ad alta portata.**Imbottitura:** Poliuretano espanso a quote differenziate, ricoperto in termofalda.**Cuscino seduta:** Poliuretano espanso a quote differenziate, ricoperto in termofalda.**Piedi:** Acciaio verniciato nero con puntale cromato.**Rivestimento:** Rivestimento in tessuto o in pelle.

Rivestimento in tessuto completamente sfoderabile.

Accessorio: bracciolo/contenitore in noce canaletto con ripiano cuoio nero**Description of the product**

Sofas, Chaise longue, Ottoman

Technical features**Frame base:** Painted metal.**Frame back:** Multilayer with adjustable tilt mechanism**Springing:** High resistance unidirectional elastic bands.**Padding:** Polyurethane foam with different densities covered with heated bonded polyester fibre.**Seat cushions:** Polyurethane foam with different densities covered with heated bonded polyester fibre.**Feet:** black varnished steel with chromed tip.**Cover:** Fabric or leather cover.

Fabric cover completely removable.

Accessory: Canaletto walnut arm/container, top with black emery leather**Produktbeschreibung**

Sofas, Chaise longue, Hocker

Technische Angaben**Korpusgestell:** lackiertes Metall.**Gestell der Rückenlehne:** Schichtholz mit durchgehendem Kettenmechanismus zur Biegung der Rückenlehne.**Federung:** Mit hochbelastbaren und unidirektionalen elastischen Gurten.**Polsterung:** Polyurethanschaumstoff verschiedenen Quoten mit thermisch gebundenen Fasern.**Sitzkissen:** Polyurethanschaumstoff verschiedenen Quoten mit thermisch gebundenen Fasern.**FüÙe:** schwarzlackierter Stahl mit Fußspitzen aus verchromt.**Bezug:** Bezug aus Stoff oder Leder.

Stoffbezug ganz abnehmbar.

Zubehör: Armlehne/Behälter in Canaletto-Walnut, Oberfläche in schwarzem Kernleder bezogen**Description du produit**

Canapés, Chaise longue, Pouf

Caractéristiques techniques**Structure:** Métal verni.**Structure dossier:** Bois multiplis avec mécanique à chaîne continue.**Suspension:** Sangles élastiques unidirectionnelles à haute résistance.**Rembourrage:** Mousse de polyuréthane des différentes densités enrobée en fibre thermomoulée.**Coussin d'assise:** Mousse de polyuréthane des différentes densités enrobée en fibre thermomoulée.**Pieds:** Acier verni noir avec embout chromé.**Revêtement:** Revêtement en tissu ou en cuir. Revêtement en tissu entièrement déhoussable.**Accessoire:** accoudoir/coffre en noyer Canaletto, avec plateau en cuir sellier noir

- A - Memory foam / Memory foam
 B - Espanso densità portante / Foam supporting density
 C - Espanso densità soft / Foam soft density
 F - Telaio in ferro / Iron frame
 L - Fusto in legno / Wooden frame
 R - Resinato / Heated bonded polyester fibre

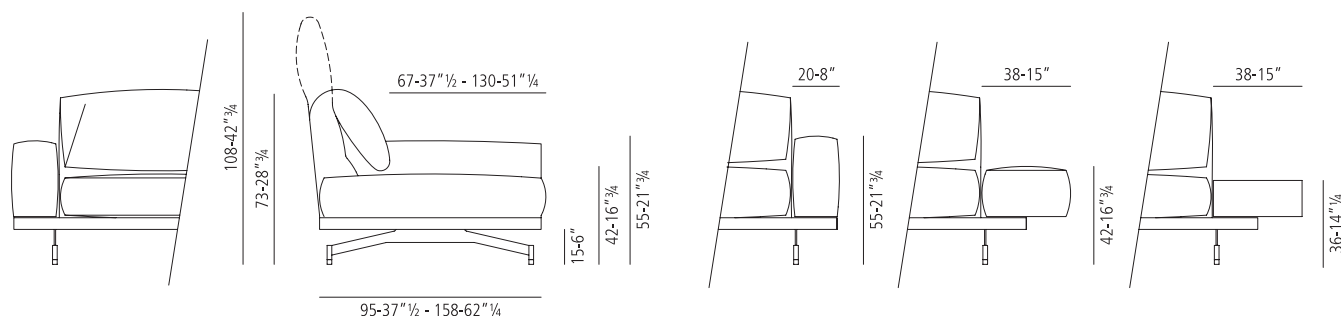
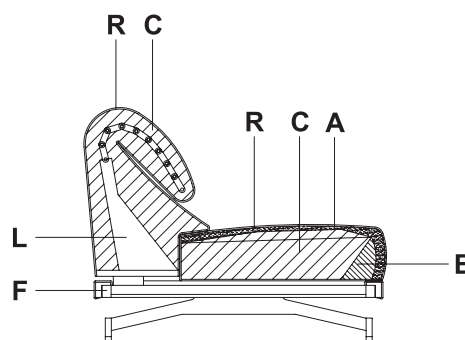

550-Altopiano

design Gianluigi Landoni

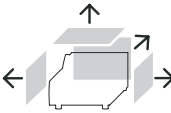
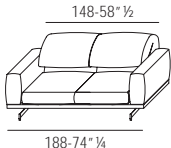
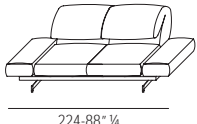
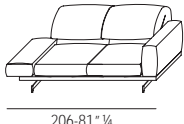
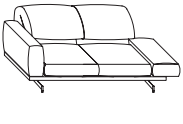
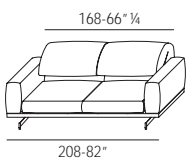
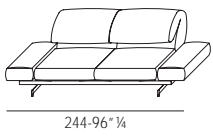
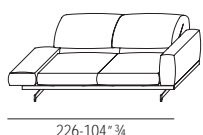
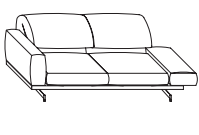
M ³	Kg.	MI.	M ²			Tessuto - Fabric					Pelle - Leather			
Volume	Peso	Tessuto	Pelle	Imballi legno	Prelavaggio	 Possibile su misura Special sizes available	Tessuto cliente	D - F - Aqua	Extra	Super	Nature	Pelle cliente	Pelle	Pelle Lusso
Volume	Weight	Fabric	Leather	Wood packaging	Prewash p. 7/10		COM					COL		
						 148-58 ¹ / ₂ 188-74 ¹ / ₄								
1,3	125	10,6	12,5	'	+10%									
						550019	4.721	4.811	5.022	5.309	5.468	5.504	6.115	7.250
							Rivestimento / Replacement cover	1.675	1.851	2.062	2.351	2.421		
						 224-88 ¹ / ₄								
1,3	125	10,6	12,5	'	+10%									
						550020	4.761	4.849	5.062	5.353	5.514	5.547	6.164	7.301
							Container Canaletto	697	cad. / each					
							Rivestimento / Replacement cover	1.689	1.866	2.081	2.372	2.443		
						 206-81 ¹ / ₄								
1,3	125	10,6	12,5	'	+10%									
						550027	4.739	4.830	5.044	5.332	5.491	5.526	6.139	7.274
							Container Canaletto	697	cad. / each					
						 206-81 ¹ / ₄								
						550026	4.739	4.830	5.044	5.332	5.491	5.526	6.139	7.274
							Rivestimento / Replacement cover	1.682	1.860	2.070	2.360	2.431		
						 168-66 ¹ / ₄ 208-82 ¹ / ₄								
1,6	152	12	14,5	'	+10%									
						550028	4.909	5.004	5.220	5.520	5.685	5.727	6.363	7.547
							Rivestimento / Replacement cover	1.739	1.924	2.142	2.442	2.516		
						 244-96 ¹ / ₄								
1,6	152	12	14,5	'	+10%									
						550029	4.949	5.042	5.263	5.565	5.732	5.772	6.413	7.599
							Container Canaletto	697	cad. / each					
							Rivestimento / Replacement cover	1.757	1.940	2.162	2.464	2.537		
						 226-104 ¹ / ₄								
1,6	152	12	14,5	'	+10%									
						550036	4.928	5.022	5.243	5.542	5.709	5.748	6.386	7.572
							Container Canaletto	697	cad. / each					
						 226-104 ¹ / ₄								
						550035	4.928	5.022	5.243	5.542	5.709	5.748	6.386	7.572
							Rivestimento / Replacement cover	1.749	1.932	2.152	2.453	2.526		

I prezzi sono espressi in Euro
 Prices are in Euro

Consultare condizione di vendita e avvertenze importanti
 Please check our sale conditions and important remarks

550-Altopiano design Gianluigi Landoni

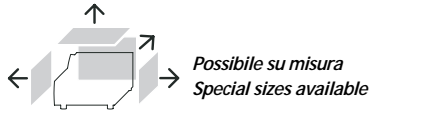
M ³	Kg.	MI.	M ²			Tessuto - Fabric					Pelle - Leather			
Volume Volume	Peso Weight	Tessuto Fabric	Pelle Leather	Imballi legno Wood packaging	Prelavaggio p. 7/10 Prewash p. 7/10		Tessuto cliente COM	D - F - Aqua	Extra	Super	Nature	Pelle cliente COL	Pelle	Pelle Lusso
					<input type="radio"/> previsto (rif. tab. pag. 3) / available: s.table p.3 <input type="radio"/> incluso / included									

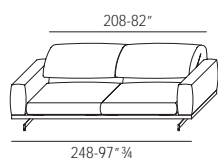

550037

1,91	163	14	16,5	'	+10%		5.334	5.441	5.684	6.024	6.205	6.268	6.964	8.280
						Rivestimento / Replacement cover	1.896	2.100	2.344	2.684	2.764			

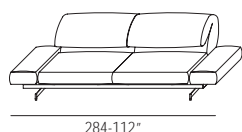

550038

1,91	163	14	16,5	'	+10%		5.371	5.480	5.724	6.068	6.250	6.311	7.013	8.333
						Container Canaletto	697	cad. / each						
						Rivestimento / Replacement cover	1.910	2.114	2.359	2.706	2.786			

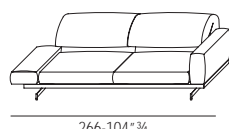

550045

1,91	163	14	16,5	'	+10%		5.353	5.460	5.703	6.047	6.228	6.291	6.989	8.307
						Container Canaletto	697	cad. / each						
						Rivestimento / Replacement cover	1.903	2.107	2.351	2.694	2.775			

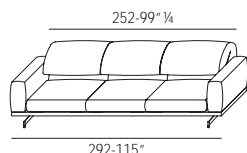

550046

2,24	195	16,5	19	'	+10%		6.791	6.921	7.219	7.627	7.856	7.949	8.833	10.514
						Rivestimento / Replacement cover	2.403	2.657	2.956	3.360	3.462			

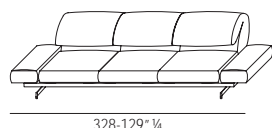

550047

2,24	195	16,5	19	'	+10%		6.829	6.959	7.262	7.671	7.901	7.994	8.882	10.568
						Container Canaletto	697	cad. / each						
						Rivestimento / Replacement cover	2.418	2.670	2.972	3.383	3.484			

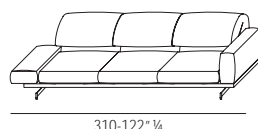

550054

2,24	195	16,5	19	'	+10%		6.812	6.940	7.242	7.649	7.879	7.972	8.858	10.540
						Container Canaletto	697	cad. / each						
						Rivestimento / Replacement cover	2.412	2.665	2.964	3.373	3.474			

I prezzi sono espressi in Euro
Prices are in Euro

Consultare condizione di vendita e avvertenze importanti
Please check our sale conditions and important remarks

550-Altopiano design Gianluigi Landoni

M ³	Kg.	MI.	M ²			Tessuto - Fabric					Pelle - Leather			
Volume Volume	Peso Weight	Tessuto Fabric	Pelle Leather	Imballi legno Wood packaging	Prelavaggio p. 7/10 Prewash p. 7/10		Tessuto cliente COM	D - F - Aqua	Extra	Super	Nature	Pelle cliente COL	Pelle	Pelle Lusso
							<input type="checkbox"/> previsto (rif. tab. pag. 3) / available: s.table p.3 <input type="checkbox"/> incluso / included							

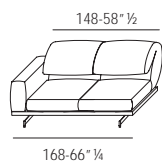

550062



550061

1,3	121	9	11,5	'	+10%		4.149	4.228	4.410	4.656	4.795	4.864	5.405	6.444
						Rivestimento / Replacement cover	1.466	1.622	1.803	2.049	2.112			

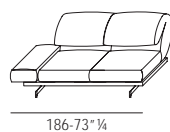

550064



550063

1,3	121	9	11,5	'	+10%		4.170	4.249	4.431	4.678	4.819	4.885	5.428	6.472
						Container Canaletto	697	cad. / each						
						Rivestimento / Replacement cover	1.475	1.628	1.813	2.060	2.122			

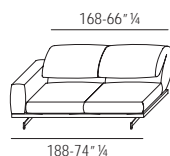

550068

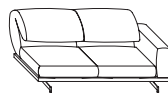

550067

1,45	132	10,4	13	'	+10%		4.339	4.422	4.611	4.867	5.013	5.088	5.653	6.741
						Rivestimento / Replacement cover	1.531	1.691	1.884	2.141	2.205			

550-Altopiano design Gianluigi Landoni

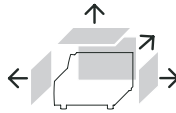
M ³	Kg.	MI.	M ²			Tessuto - Fabric					Pelle - Leather				
Volume Volume	Peso Weight	Tessuto Fabric	Pelle Leather	Imballi legno Wood packaging	Prelavaggio p. 7/10 Prewash p. 7/10	Tessuto cliente COM	D - F - Aqua	Extra	Super	Nature	Pelle cliente COL	Pelle	Pelle Lusso		
						 <p>Possibile su misura Special sizes available</p>									
						<input type="radio"/> previsto (rif. tab. pag. 3) / available: s.table p.3 incluso / included									

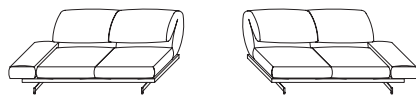

206-81*¼

550070

550069

4.357	4.439	4.631	4.888	5.034	5.110	5.677	6.768
-------	-------	-------	-------	-------	-------	-------	-------

Container Canaletto	697	cad. / each					
---------------------	-----	-------------	--	--	--	--	--

Rivestimento / Replacement cover	1.540	1.702	1.895	2.152	2.216		
----------------------------------	-------	-------	-------	-------	-------	--	--

1,45	132	10,4	13	'	+10%
------	-----	------	----	---	------

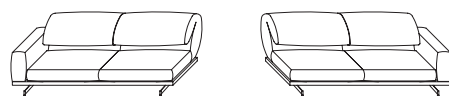

228-90*

550074

550073

4.764	4.858	5.071	5.372	5.533	5.629	6.254	7.477
-------	-------	-------	-------	-------	-------	-------	-------

Rivestimento / Replacement cover	1.689	1.870	1.942	2.383	2.454		
----------------------------------	-------	-------	-------	-------	-------	--	--

1,75	143	12,5	15	'	+10%
------	-----	------	----	---	------

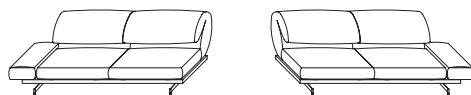

246-97*

550076

550075

4.782	4.877	5.092	5.393	5.556	5.651	6.278	7.501
-------	-------	-------	-------	-------	-------	-------	-------

Container Canaletto	697	cad. / each					
---------------------	-----	-------------	--	--	--	--	--

Rivestimento / Replacement cover	1.694	1.876	2.093	2.393	2.464		
----------------------------------	-------	-------	-------	-------	-------	--	--

1,75	143	12,5	15	'	+10%
------	-----	------	----	---	------

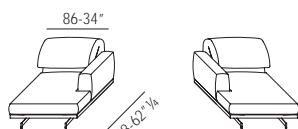

86-34*

106-41*¾

158-62*¼

550079

550080

4.274	4.374	4.597	4.907	5.055	5.192	5.769	6.933
-------	-------	-------	-------	-------	-------	-------	-------

Rivestimento / Replacement cover	1.531	1.710	1.935	2.244	2.312		
----------------------------------	-------	-------	-------	-------	-------	--	--

1,26	112	8,5	10	'	+10%
------	-----	-----	----	---	------

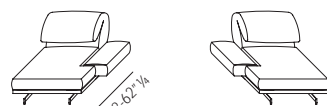

124-49*

550081

550082

4.292	4.392	4.618	4.928	5.074	5.214	5.794	6.958
-------	-------	-------	-------	-------	-------	-------	-------

Container Canaletto	697	cad. / each					
---------------------	-----	-------------	--	--	--	--	--

Rivestimento / Replacement cover	1.539	1.717	1.942	2.252	2.320		
----------------------------------	-------	-------	-------	-------	-------	--	--

1,26	112	8,5	10	'	+10%
------	-----	-----	----	---	------

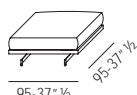

95-37*½

550085

1.723	1.782	1.898	2.067	2.128	2.282	2.535	3.092
-------	-------	-------	-------	-------	-------	-------	-------

Rivestimento / Replacement cover	630	724	848	1.062	1.094		
----------------------------------	-----	-----	-----	-------	-------	--	--

0,37	44	3,5	5	'	+10%
------	----	-----	---	---	------

I prezzi sono espressi in Euro
Prices are in Euro

Consultare condizione di vendita e avvertenze importanti
Please check our sale conditions and important remarks



Descrizione prodotto

Divani

Caratteristiche tecniche

Struttura: Massello di abete con inserti in legni composti e multistrato di pioppo

Molleggio: Nastri elastici unidirezionali ad alta portata.

Imbottitura: Poliuretano espanso ad alta densità ricoperto con resinato accoppiato vellutino

Cuscini seduta: Inserto in poliuretano espanso avvolto da materassina in piuma con fodera a sezioni separate.

Cuscini schienale: Piuma lavata e sterilizzata con fodera a sezioni separate e con tampone interno in poliuretano espanso.

Base: Massello di frassino tinto grigio ombra.

Rivestimento: Rivestimento in tessuto o in pelle. Rivestimento non sfoderabile

Finitura: Punto cavallo colori grigio scuro o corda.

Note particolari

All'ordine specificare colore di finitura.

Description of the product

Sofas

Technical features

Frame: Solid fir-wood and poplar multilayer and composite woods.

Springing: High resistance unidirectional elastic bands.

Padding: High density polyurethane foam covered with heated bonded polyester fibre.

Seat cushions: Core in polyurethane foam covered with a feather layer in separate sections.

Back cushions: Core in polyurethane foam covered with a feather layer in separate sections.

Base: Solid ash umbra grey dyed.

Cover: Non removable fabric or leather cover.

Finishing: Blanket stitching rope colour or dark grey.

Special notes

Please specify finishing colour on order.

Produktbeschreibung

Sofas

Technische Angaben

Gestell: Aus massivem Fichtenholz mit Agglomerateinlagen und Pappelschichtholz.

Federung: Mit hochbelastbaren und unidirektionalen elastischen Gurten.

Polsterung: Polyurethanschaumstoff mit hohem Raumgewicht mit samtartiger Resinatabdeckung.

Sitzkissen: Polyurethanschaumstoffeinlage mit Daunen in separaten Kammern bezogen.

Rückenkissen: Polyurethanschaumstoffkern mit gewaschenen und sterilisierten Daunen in separaten Kammern bezogen.

Fußgestell: in gebeiztem massiven Eschenholz Umbragrau gebeizt.

Bezug: Bezug aus Stoff oder Leder. Bezug nicht abnehmbar.

Finishing: Sattelnah in dunklem Grau oder Seilfarbe.

Bemerkungen

Bei der Bestellung bitte andere Nahtfarbe angeben.

Description du produit

Canapés

Caractéristiques techniques

Structure: Sapin massif, et peuplier multiplis et agglomérat.

Suspension: Sangles élastiques unidirectionnelles à haute résistance.

Rembourrage: Mousse de polyuréthane de différentes densités à haute résistance, enrobée en fibre thermomoullée.

Coussins d' assise: Mousse de polyuréthane enrobée d'un matelas en plume lavée et stérilisée en sections distinctes.

Coussins de dossier: Plume lavée et stérilisée en sections distinctes avec élément intercalaire en mousse

Pieds: Massif de frêne teinté gris Terre d'ombre.

Revêtement: Revêtement en tissu ou en cuir. Revêtement pas déhoussable.

Finitions: Couture point de feston corde ou gris foncé.

Remarques

À la commande spécifier la couleur de la finition.

B - Espanso densità portante / Foam supporting density

C - Espanso densità soft / Foam soft density

P - Piuma / Feather

L - Fusto in legno / Wooden frame

R - Resinato / Heated bonded polyester fibre

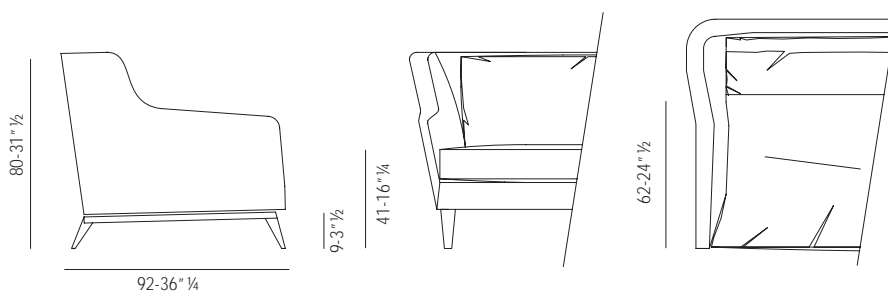
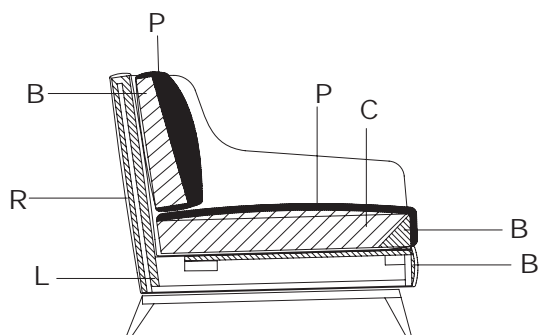

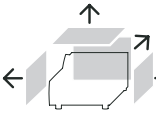
M ³	Kg.	MI.	M ²			Tessuto - Fabric					Pelle - Leather			
Volume Volume	Peso Weight	Tessuto Fabric	Pelle Leather	Imballi legno Wood packaging	Prelavaggio p. 7/10 Prewash p. 7/10	 <p>Possibile su misura Special sizes available</p>	Tessuto cliente COM	D - F - Aqua	Extra	Super	Nature	Pelle cliente COL	Pelle	Pelle Lusso
<input type="checkbox"/> previsto (rif. tab. pag. 3) / available: s.table p.3 incluso / included														

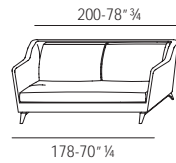

575002

1,55	58	15,0	15,0	'		4.871	4.961	5.190	5.464	5.628	7.023	7.804	9.301
------	----	------	------	---	--	-------	-------	-------	-------	-------	-------	-------	-------

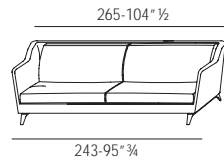

575003

1,95	84	15,6	16,0	'		5.413	5.512	5.765	6.070	6.251	7.805	8.672	10.334
------	----	------	------	---	--	-------	-------	-------	-------	-------	-------	-------	--------

**Descrizione prodotto**

Divani, pouf

Caratteristiche tecniche**Struttura:** telaio multistrato di pioppo con struttura portante in metallo, cinghie elastiche su schienali**Molleggio:** nastri elastici unidirezionali ad alta portata**Imbottitura:** poliuretano espanso ricoperto con resinato accoppiato vellutino**Cuscini seduta:** poliuretano espanso a quote differenziate e memory ricoperto in termolegato cotone 100%**Cuscini bracciolo con meccanismo:** inserto in poliuretano espanso avvolto da materassina in piuma**Meccanismo bracciolo:** reclinabile in 6 posizioni diverse**Gambe:** metallo brunito**Rivestimento:** rivestimento in tessuto o in pelle. Rivestimento in tessuto completamente sfoderabile**Accessori:**

- cassetto in MDF impiallacciato rovere tinto grigio ombra, inserto in cuoio (vedi catalogo)

- cuscini schienale con rullo: in fibra poliestere siliconata ricoperta da fodera cotone 100%.

Note particolari**I cuscini schienale non sono compresi nel costo dei divani.****Description of the product**

Sofas, Ottoman

Technical features**Frame:** solid poplar wood and iron supports for back and frame. Elastic bands for back.**Springing:** high resistance unidirectional elastic bands**Padding:** polyurethane foam covered with heated bonded polyester fibre**Seat cushions:** polyurethane foam with different densities and memory covered with heated banded polyester fibre**Adjustable arm cushion:** core in polyurethane foam covered with a feather layer**Arm mechanism:** adjustable in 6 different positions**Feet:** burnished metal**Cover:** fabric or leather cover. Fabric cover removable**Accessories:**

- drawer multilayer MDF veneered with oak dyed

- umbra grey. Emery leather insert (see catalog),

- back cushions with roll: in silicone polyester fibre covered with 100% cotton lining.

Special notes**Back cushions are not included in the sofas price.****Produktbeschreibung**

Sofas, Hocker

Technische Angaben**Gestell:** Pappelschichtholz m. Traggestell aus Metall.

Ruchenlehne m. elastischen Gurten

Federung: mit hochbelastbaren und unidirektionalem elastischen Gurten**Polsterung:** Polyurethanschaumstoff mit samtartiger Resinat Abdeckung**Sitzkissen:** Polyurethanschaumstoff in verschiedenen Quoten und Memory mit thermisch gebundenen Fasern mit 100% Baumwolle**Armlehnenkissen mit Mechanismus:**

Polyurethanschaumstoffinlage mit Daunen

Mechanismus für Schlußteil: in 6 verschiedenen Positionen klappbar**FüÙe:** Brünirtes Metall**Bezug:** Bezug aus Stoff oder Leder. Stoffbezug ganz abnehmbar**Zubehore:**

- Schublade in MDF mit Umbragrau gebeizter Eiche

- furniert, Ablage au Kernleder (s. Katalog)

- Rollenrückenkissen: Silikon-Polyester-Fasern mit einem Bezug aus 100% Baumwolle.

Bemerkungen**Die Rückenissen sind extra zu bestellen.****Description du produit**

Canapés, Pouf

Caractéristiques techniques**Structure:** aggloméré de peuplier avec structure en fer, sangles élastiques sur dossier**Suspension:** sangles élastiques unidirectionnelles à haute résistance**Rembourrage:** mousse de polyuréthane de différents densités, enrobée en fibre thermomoullée**Coussins d'assise:** mousse de polyuréthane de différentes densités et Memory enrobée en fibre thermomoullée recouverte de coton 100%.**Coussin accoudoir avec mécanisme:** mousse de polyuréthane enrobée d'un matelas en plume**Mécanisme accoudoir:** inclination en 6 différentes positions**Pieds:** métal bruni**Revêtement:** revêtement en tissu ou en cuir.

Revêtement en tissu entièrement déhoussable

Accessoires:

- tiroir en MDF plaqué en chêne teinté gris ombre,

insert en cuir sellier (voir catalogue)

- coussins de dossier avec rouleau: fibre en polyester siliconée recouverte de coton 100%.

Remarques**Les coussins de dossier ne sont pas inclus dans les canapés.**

B - Espanso densità portante / Foam supporting density

C - Espanso densità soft / Foam soft density

L - Fusto in legno / Wooden frame

P - Piuma / Feather

R - Resinato / Heated bonded polyester fibre

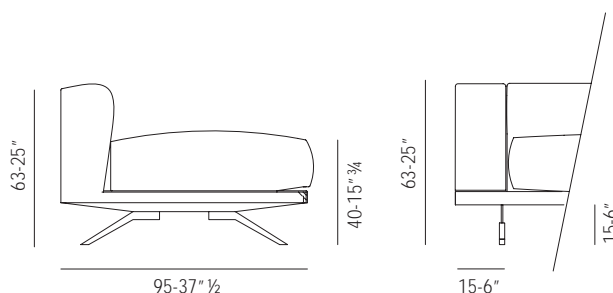
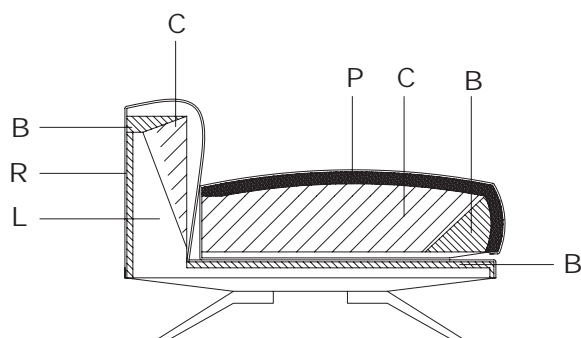

M ³	Kg.	MI.	M ²			Tessuto - Fabric					Pelle - Leather			
Volume	Peso	Tessuto	Pelle	Imballi legno	Prelavaggio p. 7/10		Tessuto cliente	D - F - Aqua	Extra	Super	Nature	Pelle cliente	Pelle	Pelle Lusso
Volume	Weight	Fabric	Leather	Wood packaging	Prewash p. 7/10		COM					COL		
						<input type="radio"/> previsto (rif. tab. pag. 3) / available: s.table p.3 <input type="radio"/> incluso / included								



580001

0,04	7	1,7	3		+10%									
						Rivestimento / Replacement cover	391	407	434	487	501	572	636	796
							245	265	294	345	355	450	499	659

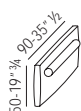

580002

0,05	8	3,2	5		+10%									
						Rivestimento / Replacement cover	447	466	499	560	576	658	730	913
							281	304	338	397	409	516	573	756

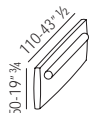

580003

0,06	9	3,2	5		+10%									
						Rivestimento / Replacement cover	489	508	543	609	627	718	797	996
							307	332	368	431	445	563	625	824

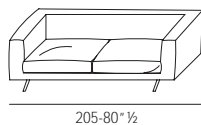

580005

1,2	70	10	13,7		+10%									
						Rivestimento / Replacement cover	3.814	3.947	4.206	4.582	4.721	5.205	5.784	6.939
							1.818	2.007	2.264	2.642	2.722			

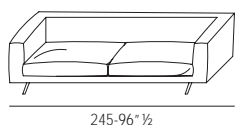

580006

1,4	84	11,1	15,5		+10%									
						Rivestimento / Replacement cover	4.147	4.291	4.571	4.981	5.131	5.659	6.287	7.544
							1.974	2.180	2.461	2.871	2.956			

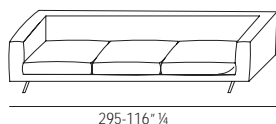

580007

1,80	101	14,6	18,2		+10%									
						Rivestimento / Replacement cover	5.058	5.234	5.575	6.077	6.258	6.902	7.669	9.204
							2.410	2.662	3.000	3.502	3.606			

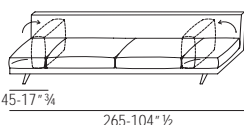

580009

1,60	91	14	18,4		+10%									
						Rivestimento / Replacement cover	4.718	4.877	5.200	5.667	5.838	6.437	7.152	8.583
							2.418	2.725	3.125	3.713	3.825			

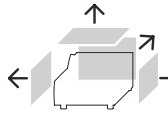
M ³	Kg.	MI.	M ²			Tessuto - Fabric					Pelle - Leather				
Volume Volume	Peso Weight	Tessuto Fabric	Pelle Leather	Imballi legno Wood packaging	Prelavaggio p. 7/10 Prewash p. 7/10	Tessuto cliente COM	D - F - Aqua	Extra	Super	Nature	Pelle cliente COL	Pelle	Pelle Lusso		
						 <p>Possibile su misura Special sizes available</p> <p>○ previsto (rif. tab. pag. 3) / available: s.table p.3 incluso / included</p>									

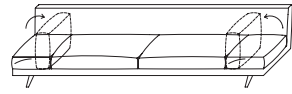

45-17*³/₄
305-120*

580010

1,80	105	15,2	20	'	+10%		5.213	5.396	5.744	6.262	6.450	7.113	7.903	9.483
						Rivestimento / Replacement cover	2.652	2.987	3.418	4.055	4.176			

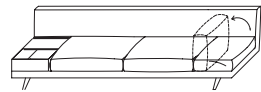

45-17*³/₄
265-104*¹/₂

580016

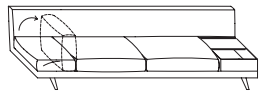

580015

1,60	91	12	16	'	+10%		5.384	5.529	5.848	6.315	6.502	7.008	7.781	9.212
						Rivestimento / Replacement cover	2.128	2.405	2.763	3.290	3.389			

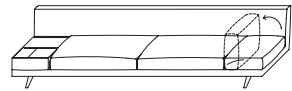

45-17*³/₄
305-120*

580019

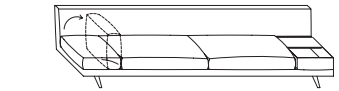

580018

1,80	105	13,2	17,6	'	+10%		5.879	6.042	6.393	6.910	7.115	7.684	8.531	10.111
						Rivestimento / Replacement cover	2.364	2.666	3.057	3.633	3.743			

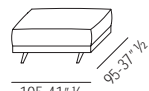

105-41*¹/₂
95-37*¹/₂

580022

0,50	25	3,50	4,60	'	+10%		1.641	1.697	1.808	1.969	2.029	2.237	2.485	3.031
						Rivestimento / Replacement cover	781	862	973	1.134	1.168			



Descrizione prodotto

Poltrona, divani

Caratteristiche tecniche

Struttura: Massello di abete e legno multistrato.

Molleggio: Nastri elastici unidirezionali ad alta portata.

Imbottitura: Poliuretano espanso a quote differenziate e memory ricoperto in termolegato cotone 100%.

Piedi: Legno laccato nero.

Rivestimento: Rivestimento in tessuto o in pelle. Rivestimento non sfoderabile.

Description of the product

Armchair, sofas

Technical features

Frame: Solid fir-wood and multilayer.

Springing: High resistance unidirectional elastic bands.

Seat and backrest padding: Polyurethane foam with different densities and memory covered with heated bonded polyester fibre.

Feet: Black lacquered wood.

Cover: Non-removable fabric or leather cover.

Produktbeschreibung

Sessel, Sofas

Technische Angaben

Gestell: Aus massivem Fichtenholz und Schichtholz.

Federung: Mit hochbelastbaren und unidirektionalen elastischen Gurten.

Sitz- und Rückenlehnpolsterung: Polyrethanschaumstoff in verschiedenen Quoten und Memory mit thermisch gebundenen Fasern mit 100%.

FüÙe: aus schwarzlackiertem Holz.

Bezug: Bezug aus Stoff oder Leder.

Bezug nicht abnehmbar.

Description du produit

Fauteuil, canapés

Caractéristiques techniques

Structure: Sapin massif et multiplis.

Suspension: Sangles élastiques unidirectionnelles à haute résistance.

Rembourrage assise et dossier: mousse de polyurethane de différentes densités et memory, enrobée En fibre thermomoullée recouverte de coton 100%.

Pieds: bois laqué noir.

Revêtement: revêtement en tissu ou en cuir.

Revêtement pas déhoussable.

- A - Memory foam / Memory foam
- B - Espanso densità portante / Foam supporting density
- C - Espanso densità soft / Foam soft density
- L - Fusto in legno / Wooden frame
- R - Resinato / Heated bonded polyester fibre

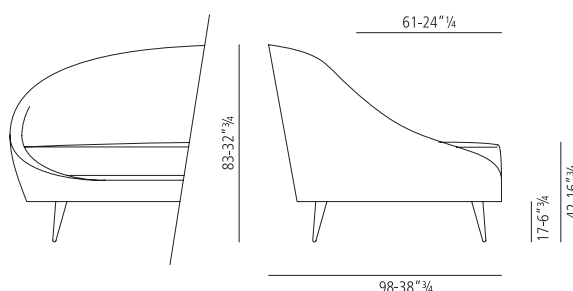
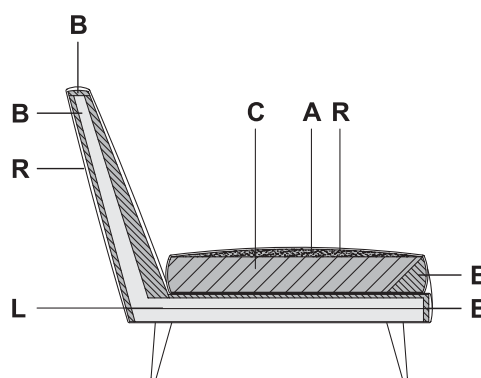

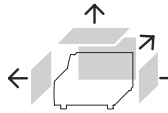
M ³	Kg.	MI.	M ²			Tessuto - Fabric					Pelle - Leather			
Volume Volume	Peso Weight	Tessuto Fabric	Pelle Leather	Imballi legno Wood packaging	Prelavaggio p. 7/10 Prewash p. 7/10	 <p>Possibile su misura Special sizes available</p>	Tessuto cliente COM	D - F - Aqua	Extra	Super	Nature	Pelle cliente COL	Pelle	Pelle Lusso
							<input type="radio"/> previsto (rif. tab. pag. 3) / available: s.table p.3 incluso / included							

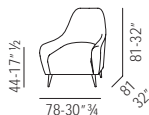

0,29	12	6	8	'	650001	tessuto / fabric	2.418	2.403	2.455	2.544	2.620	2.702	3.003	3.442
					650003	Esterno pelle / External backrest leather	3.161	3.125	3.179	3.265	3.362			

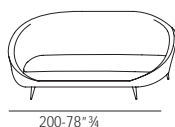

1,36	45	11,5	18,5	'	650004	tessuto / fabric	4.627	4.661	4.824	5.087	5.240	5.027	5.586	6.402
					650006	Esterno pelle / External backrest leather	5.950	5.882	5.979	6.137	6.322			

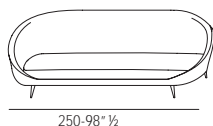

1,54	55	13	22	'	650007	tessuto / fabric	5.201	5.252	5.450	5.764	5.936	5.744	6.382	7.359
					650009	Esterno pelle / External backrest leather	6.855	6.776	6.891	7.075	7.286			



Descrizione prodotto
Divani, Poltrone, Pouf, Poltroncina

Caratteristiche tecniche

Struttura: Massello di abete.

Molleggio: Nastri elastici unidirezionali ad alta portata.

Imbottitura: Poliuretano espanso.

Cuscini seduta: Inserto in poliuretano espanso avvolto da materassina in piuma.

Piedi: Legno noce canaletto o metallo verniciato brunito.

Rivestimento: Rivestimento in tessuto o in pelle. Rivestimento in tessuto completamente sfoderabile.

Note particolari

All'ordine specificare tipo di piede.

Description of the product

Sofas, Armchairs, Ottoman, Small Armchair

Technical features

Frame: Solid fir-wood.

Springing: High resistance unidirectional elastic bands.

Padding: Polyurethane foam.

Seat cushions: Core in polyurethane foam covered with a feather layer.

Feet: Canaletto walnut or burnish varnished metal.

Cover: Fabric or leather cover.

Fabric cover completely removable.

Special notes

Please specify type of feet on order.

Produktbeschreibung

Sofas, Sessel, Hocker, Kleine Sessel

Technische Angaben

Gestell: Aus massivem Fichtenholz.

Federung: Mit hochbelastbaren und unidirektionalen elastischen Gurten.

Polsterung: Polyurethanschaumstoff.

Sitzkissen: Polyurethanschaumstoffeinlage mit Daunen.

FüÙe: Canaletto WalnuÙ oder brüniertes lackiertes Metall.

Bezug: Bezug aus Stoff oder Leder. Stoffbezug ganz abnehmbar.

Bemerkungen

Bei der Bestellung bitte Art der FüÙe angeben.

Description du produit

Canapés, Fauteuils, Pouf, Petite fauteuil

Caractéristiques techniques

Structure: Sapin massif.

Suspension: Sangles élastiques unidirectionnelles à haute résistance.

Rembourrage: Mousse de polyuréthane.

Coussins d'assise: Mousse de polyuréthane enrobée d'un matelas en plume.

Pieds: Bois noyer Canaletto ou métal verni bruni.

Revêtement: Revêtement en tissu ou en cuir. Revêtement en tissu entièrement déhoussable.

Remarques

À la commande spécifier le type du pied.

- B - Espanso densità portante / Foam supporting density
- C - Espanso densità soft / Foam soft density
- L - Fusto in legno / Wooden frame
- R - Resinato / Heated bonded polyester fibre
- P - Piuma / Feather

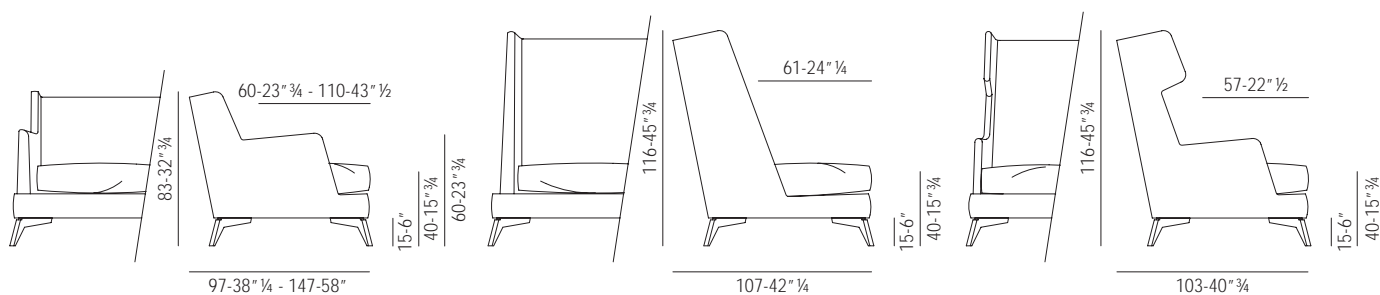
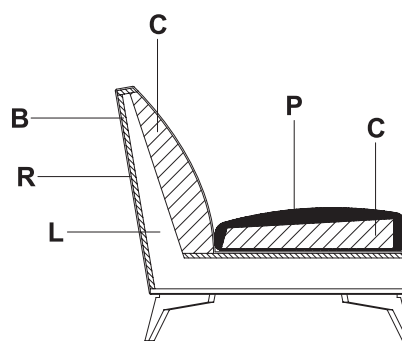

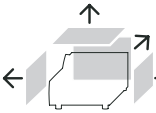
M ³	Kg.	MI.	M ²			 <i>Possibile su misura</i> <i>Special sizes available</i>	Tessuto - Fabric					Pelle - Leather		
Volume Volume	Peso Weight	Tessuto Fabric	Pelle Leather	Imballi legno Wood packaging	Prelavaggio p. 7/10 Prewash p. 7/10		<input type="radio"/> previsto (rif. tab. pag. 3) / available: s.table p.3 <input type="radio"/> incluso / included	Tessuto cliente COM	D - F - Aqua	Extra	Super	Nature	Pelle cliente COL	Pelle

						 680001									
1,07	51	6,5	8,5	'	+10%	Rivestimento / Replacement cover	2.539	2.627	2.799	3.046	3.139	3.363	3.736	4.557	
							1.247	1.371	1.542	1.803	1.857				

						 680002									
0,81	48	6	8	'	+10%	Rivestimento / Replacement cover	2.219	2.295	2.446	2.665	2.745	2.939	3.266	3.983	
							1.092	1.199	1.351	1.578	1.626				

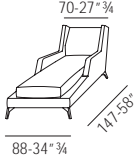
						 680003									
1,17	57	7,2	9,5	'	+10%	Rivestimento / Replacement cover	2.499	2.588	2.755	2.999	3.089	3.312	3.679	4.488	
							1.229	1.353	1.519	1.777	1.831				

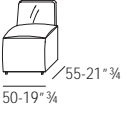
						 680007									
0,23	22	2,5	3,5	'	+10%	Rivestimento / Replacement cover	1.046	1.092	1.175	1.314	1.353	1.570	1.745	2.128	
							486	550	630	777	801				

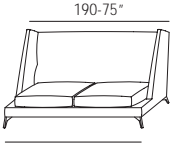
						 680004									
2,57	105	13,5	17	'	+10%	Rivestimento / Replacement cover	3.690	3.787	4.031	4.393	4.526	4.851	5.391	6.574	
							1.800	1.976	2.225	2.600	2.679				

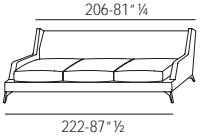
						 680005									
2	92	12	15	'	+10%	Rivestimento / Replacement cover	4.025	4.164	4.433	4.834	4.980	5.334	5.927	7.231	
							1.978	2.175	2.446	2.865	2.950				

I prezzi sono espressi in Euro
Prices are in Euro

Consultare condizione di vendita e avvertenze importanti
Please check our sale conditions and important remarks

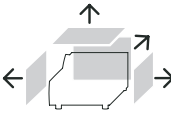
M ³	Kg.	MI.	M ²			 <i>Possibile su misura</i> <i>Special sizes available</i>	Tessuto - Fabric					Pelle - Leather		
Volume Volume	Peso Weight	Tessuto Fabric	Pelle Leather	Imballi legno Wood packaging	Prelavaggio p. 7/10 Prewash p. 7/10		<input type="radio"/> previsto (rif. tab. pag. 3) / available: s.table p.3 <input type="radio"/> incluso / included	Tessuto cliente COM	D - F - Aqua	Extra	Super	Nature	Pelle cliente COL	Pelle

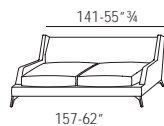

1,4	70	10	13	'	+10%	680008		3.219	3.334	3.546	3.869	3.985	4.268	4.742	5.785
								1.451	1.501	1.597	1.741	1.794			

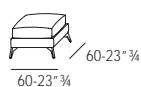

0,19	27	2,5	3	'	+10%	680006		1.122	1.174	1.262	1.410	1.452	1.638	1.821	2.219
							Rivestimento / Replacement cover	466	536	624	779	803			

**Descrizione prodotto**

Divani, Divani componibili, Chaises longues, Pouf

Caratteristiche tecniche

Struttura: Massello di abete.

Molleggio: Nastri elastici unidirezionali ad alta portata.

Imbottitura: Poliuretano espanso.

Cuscini seduta: Inserto in poliuretano espanso avvolto da materassina in piuma.

Cuscini schienale: Piuma lavata e sterilizzata con tampone interno in poliuretano espanso.

Cuscino terminale: Inserto in poliuretano espanso avvolto da materassina in piuma.

Meccanismo terminale: Reclinabile in 5 diverse posizioni.

Piedi: Tecnici neri.

Finitura: Barra anteriore in alluminio.

Rivestimento: Rivestimento in tessuto o in pelle. Rivestimento in tessuto completamente sfoderabile.

Note particolari

Nelle composizioni è necessario il disegno.

Description of the product

Sofas, Unit sofas, Chaises longues, Ottoman

Technical features

Frame: Solid fir-wood.

Springing: High resistance unidirectional elastic bands.

Padding: Polyurethane foam.

Seat cushions: Core in polyurethane foam covered with a feather layer.

Back cushions: Core in polyurethane foam covered with a feather layer.

End element cushion: Core in polyurethane foam covered with a feather layer.

End element mechanism: Adjustable in 5 different positions.

Feet: Black standard.

Finishing: Front aluminium bar.

Cover: Fabric or leather cover.

Fabric cover completely removable.

Special notes

For compositions, please supply the drawing.

Produktbeschreibung

Sofas, Anbauelemente, Chaises longues, Hocker

Technische Angaben

Gestell: Aus massivem Fichtenholz.

Federung: Mit hochbelastbaren und unidirektionalen elastischen Gurten.

Polsterung: Polyurethanschaumstoff.

Sitzkissen: Polyurethanschaumstoffeinlage mit Daunen.

Rückenkissen: Daune mit Polyurethanschaumstoffkern.

Schlußteilkissen: Polyurethanschaumstoffeinlage mit Daunen.

Mechanismus für Schlußteil: In 5 verschiedenen Positionen klappbar.

FüÙe: Standard schwarz.

Finish: Aluminiumstange vorne.

Bezug: Bezug aus Stoff oder Leder. Stoffbezug ganz abnehmbar.

Bemerkungen

Im Falle von Kombinationen bitte Skizze beilegen.

Description du produit

Canapés, Canapés modulables, Chaises longues, Pouf

Caractéristiques techniques

Structure: Sapin massif.

Suspension: Sangles élastiques unidirectionnelles à haute résistance.

Rembourrage: Mousse de polyuréthane.

Coussins d'assise: Mousse de polyuréthane enrobée d'un matelas en plume.

Coussins de dossier: Plume lavée et stérilisée avec élément intercalaire en mousse.

Coussin terminal: Mousse de polyuréthane enrobée d'un matelas en plume.

Mécanisme terminal: Inclination en 5 différents positions.

Pieds: Standard noirs.

Finissage: Barre en aluminium.

Revêtement: Revêtement en tissu ou en cuir. Revêtement en tissu entièrement déhoussable.

Remarques

Pour les compositions un dessin est indispensable.

B - Espanso densità portante / Foam supporting density

C - Espanso densità soft / Foam soft density

L - Fusto in legno / Wooden frame

P - Piuma / Feather

R - Resinato / Heated bonded polyester fibre

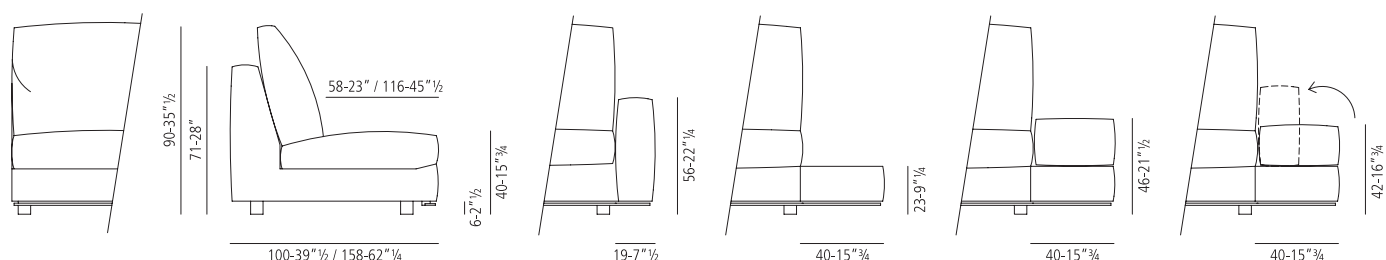
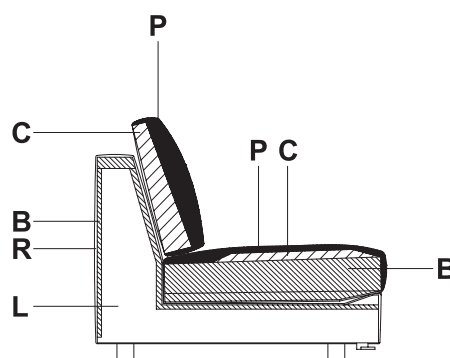

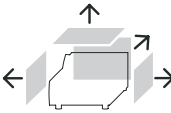
M ³	Kg.	MI.	M ²			Tessuto - Fabric					Pelle - Leather			
Volume Volume	Peso Weight	Tessuto Fabric	Pelle Leather	Imballi legno Wood packaging	Prelavaggio p. 7/10 Prewash p. 7/10	 <p>Possibile su misura Special sizes available</p>	Tessuto cliente COM	D - F - Aqua	Extra	Super	Nature	Pelle cliente COL	Pelle	Pelle Lusso
							<input type="radio"/> previsto (rif. tab. pag. 3) / available: s.table p.3 <input type="radio"/> incluso / included							

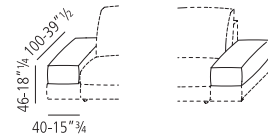

810129

810128

0,13	9	1,8	3,6		+10%		472	490	527	587	606	682	757	926
						Rivestimento / Replacement cover	228	241	283	354	365			



88-34³/₄

810001

0,7	48	7,5	10,5	'	+10%		1.872	1.937	2.064	2.249	2.317	2.484	2.760	3.364
						Rivestimento / Replacement cover	749	851	979	1.177	1.213			



107-42¹/₄

810003

810002

0,88	61	9,2	13	'	+10%		2.272	2.364	2.547	2.809	2.894	3.140	3.489	4.290
						Rivestimento / Replacement cover	949	1.086	1.268	1.551	1.597			



128-50¹/₂

810005

810004

1,03	56	9,1	12,5	'	+10%		2.261	2.357	2.536	2.799	2.883	3.126	3.474	4.273
						Rivestimento / Replacement cover	948	1.085	1.264	1.545	1.592			

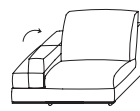

128-50¹/₂

810007

810006

1,03	63	10,9	16,1	'	+10%		3.019	3.126	3.344	3.665	3.775	4.029	4.477	5.444
						Rivestimento / Replacement cover	1.159	1.322	1.542	1.887	1.943			

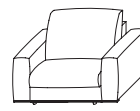

126-49³/₄

810008

1,05	74	10,9	15,5	'	+10%		2.670	2.791	3.031	3.370	3.471	3.797	4.219	5.219
						Rivestimento / Replacement cover	1.150	1.320	1.557	1.922	1.979			

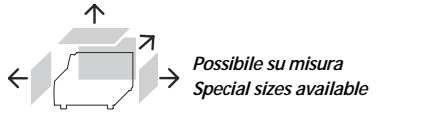
M ³	Kg.	MI.	M ²			Tessuto - Fabric					Pelle - Leather		
Volume Volume	Peso Weight	Tessuto Fabric	Pelle Leather	Imballi legno Wood packaging	Prelavaggio p. 7/10 Prewash p. 7/10								
 <p>Possibile su misura Special sizes available</p>						Tessuto cliente COM	D - F - Aqua	Extra	Super	Nature	Pelle cliente COL	Pelle	Pelle Lusso
						<input type="radio"/> previsto (rif. tab. pag. 3) / available: s.table p.3 incluso / included							



147-58"

810010



810009

1,2	69	10,8	15	'	+10%		2.662	2.785	3.020	3.358	3.460	3.785	4.206	5.199
						Rivestimento / Replacement cover	1.147	1.318	1.555	1.919	1.976			

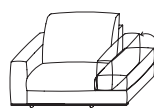

147-58"

810012

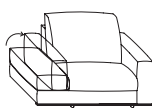

810011

1,2	76	12,6	18,6	'	+10%		3.418	3.554	3.828	4.224	4.351	4.686	5.207	6.370
						Rivestimento / Replacement cover	1.358	1.557	1.831	2.257	2.326			

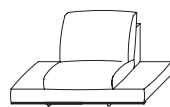

168-66"¼

810013

1,35	64	10,7	14,5	'	+10%		2.650	2.776	3.009	3.347	3.446	3.770	4.190	5.182
						Rivestimento / Replacement cover	1.146	1.317	1.552	1.914	1.971			

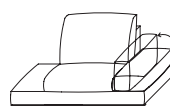

168-66"¼

810015

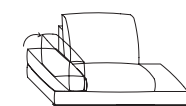

810014

1,35	71	12,5	18,1	'	+10%		3.407	3.546	3.817	4.214	4.340	4.674	5.193	6.352
						Rivestimento / Replacement cover	1.356	1.556	1.829	2.253	2.321			

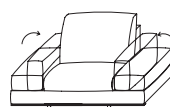

168-66"¼

810016

1,35	78	14,3	21,7	'	+10%		4.165	4.317	4.624	5.080	5.231	5.576	6.195	7.523
						Rivestimento / Replacement cover	1.567	1.795	2.107	2.595	2.672			

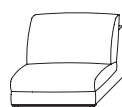

108-42"¾

810017

0,87	56	8,3	11,5	'	+10%		1.970	2.038	2.170	2.364	2.435	2.610	2.900	3.536
						Rivestimento / Replacement cover	786	889	1.024	1.235	1.272			

I prezzi sono espressi in Euro
Prices are in Euro

Consultare condizione di vendita e avvertenze importanti
Please check our sale conditions and important remarks

M ³	Kg.	MI.	M ²				Tessuto - Fabric					Pelle - Leather		
Volume Volume	Peso Weight	Tessuto Fabric	Pelle Leather	Imballi legno Wood packaging	Prelavaggio p. 7/10 Prewash p. 7/10		<input type="radio"/> previsto (rif. tab. pag. 3) / available: s.table p.3 <input type="radio"/> incluso / included	Tessuto cliente COM	D - F - Aqua	Extra	Super	Nature	Pelle cliente COL	Pelle

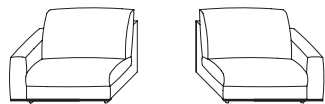

127-50"

810019

810018

1,04	69	10	14	'	+10%		2.369	2.465	2.654	2.924	3.012	3.267	3.630	4.463
						Rivestimento / Replacement cover	986	1.123	1.314	1.608	1.657			

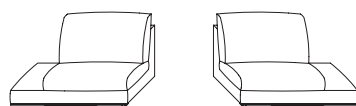

148-58"½

810021

810020

1,19	64	9,9	13,5	'	+10%		2.358	2.457	2.642	2.913	3.000	3.253	3.614	4.445
						Rivestimento / Replacement cover	985	1.122	1.309	1.605	1.652			

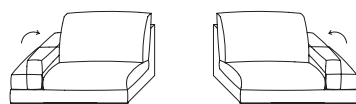

148-58"½

810023

810022

1,19	71	11,7	17,1	'	+10%		3.116	3.229	3.449	3.779	3.892	4.155	4.617	5.616
						Rivestimento / Replacement cover	1.194	1.361	1.589	1.943	2.002			

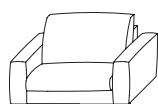

146-57"½

810024

1,21	82	11,7	16,5	'	+10%		2.768	2.891	3.139	3.484	3.589	3.923	4.358	5.391
						Rivestimento / Replacement cover	1.186	1.358	1.605	1.978	2.038			

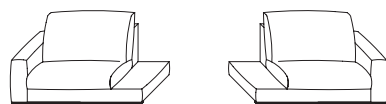

167-65"¾

810026

810025

1,36	77	11,6	16	'	+10%		2.759	2.883	3.125	3.472	3.578	3.911	4.346	5.371
						Rivestimento / Replacement cover	1.182	1.356	1.599	1.974	2.034			

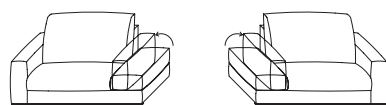

167-65"¾

810028

810027

1,36	84	13,4	19,6	'	+10%		3.516	3.656	3.934	4.339	4.468	4.813	5.348	6.542
						Rivestimento / Replacement cover	1.393	1.596	1.877	2.316	2.386			

I prezzi sono espressi in Euro
Prices are in Euro

Consultare condizione di vendita e avvertenze importanti
Please check our sale conditions and important remarks

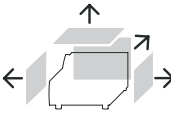
M ³	Kg.	MI.	M ²			Tessuto - Fabric					Pelle - Leather			
Volume Volume	Peso Weight	Tessuto Fabric	Pelle Leather	Imballi legno Wood packaging	Prelavaggio p. 7/10 Prewash p. 7/10	 <p>Possibile su misura Special sizes available</p>	Tessuto cliente COM	D - F - Aqua	Extra	Super	Nature	Pelle cliente COL	Pelle	Pelle Lusso
							<input type="radio"/> previsto (rif. tab. pag. 3) / available: s.table p.3 <input type="radio"/> incluso / included							

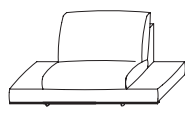

188-74"¼

810029

1,36	72	11,5	15,5	'	+10%		2.747	2.878	3.114	3.461	3.564	3.899	4.332	5.354
						Rivestimento / Replacement cover	1.180	1.355	1.597	1.971	2.031			

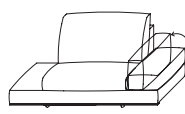

188-74"¼

810031

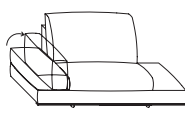

810030

1,36	79	13,3	19,1	'	+10%		3.504	3.646	3.922	4.328	4.458	4.801	5.334	6.523
						Rivestimento / Replacement cover	786	889	1.024	1.235	1.272			

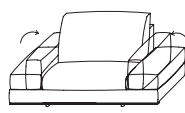

188-74"¼

810032

1,36	86	15,1	22,7	'	+10%		4.262	4.418	4.731	5.193	5.349	5.703	6.337	7.694
						Rivestimento / Replacement cover	1.602	1.833	2.152	2.652	2.732			



135-53"¼

810033

1,06	69	11	14	'	+10%		2.662	2.754	2.933	3.194	3.290	3.527	3.918	4.778
						Rivestimento / Replacement cover	1.159	1.299	1.481	1.764	1.816			



154-60"¾

810035



810034

1,23	82	12,7	16,5	'	+10%		3.059	3.180	3.418	3.754	3.867	4.185	4.649	5.703
						Rivestimento / Replacement cover	1.358	1.533	1.770	2.137	2.202			



175-69"

810037



810036

1,38	77	12,6	16	'	+10%		3.050	3.172	3.404	3.743	3.855	4.172	4.636	5.685
						Rivestimento / Replacement cover	1.356	1.531	1.768	2.134	2.198			

I prezzi sono espressi in Euro
Prices are in Euro

Consultare condizione di vendita e avvertenze importanti
Please check our sale conditions and important remarks

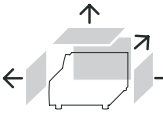
M ³	Kg.	MI.	M ²			Tessuto - Fabric					Pelle - Leather		
Volume Volume	Peso Weight	Tessuto Fabric	Pelle Leather	Imballi legno Wood packaging	Prelavaggio p. 7/10 Prewash p. 7/10								
 <p>Possibile su misura Special sizes available</p>						Tessuto cliente COM	D - F - Aqua	Extra	Super	Nature	Pelle cliente COL	Pelle	Pelle Lusso
						<input type="radio"/> previsto (rif. tab. pag. 3) / available: s.table p.3 incluso / included							

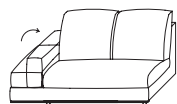

175-69"

810039

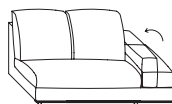

810038

1,38	84	14,4	19,6	'	+10%		3.806	3.943	4.214	4.610	4.748	5.073	5.637	6.858
						Rivestimento / Replacement cover	1.567	1.770	2.045	2.476	2.550			

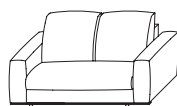

173-68"½

810040

1,4	95	14,4	19	'	+10%		3.459	3.611	3.902	4.314	4.445	4.841	5.379	6.631
						Rivestimento / Replacement cover	1.559	1.768	2.060	2.510	2.585			

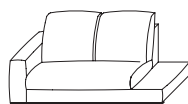

194-76"½

810042

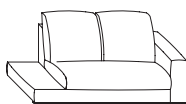

810041

1,55	90	14,3	18,5	'	+10%		3.448	3.598	3.888	4.303	4.431	4.828	5.364	6.613
						Rivestimento / Replacement cover	1.766	2.006	2.335	2.845	2.931			

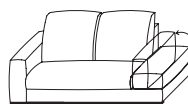

194-76"½

810044

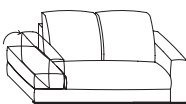

810043

1,55	97	16,1	22,1	'	+10%		4.207	4.370	4.698	5.169	5.324	5.732	6.368	7.783
						Rivestimento / Replacement cover	1.765	2.004	2.332	2.841	2.926			

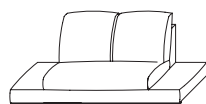

215-84"¾

810045

1,7	85	14,2	18	'	+10%		3.439	3.591	3.878	4.292	4.421	4.817	5.352	6.596
						Rivestimento / Replacement cover	1.554	1.764	2.054	2.499	2.574			

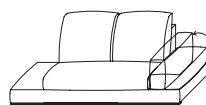

215-84"¾

810047

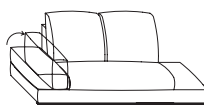

810046

1,7	92	16	21,6	'	+10%		4.195	4.361	4.685	5.159	5.312	5.718	6.353	7.764
						Rivestimento / Replacement cover	1.765	2.004	2.332	2.841	2.926			

I prezzi sono espressi in Euro
Prices are in Euro

Consultare condizione di vendita e avvertenze importanti
Please check our sale conditions and important remarks

