



IT_Descrizione prodotto

Divani, Terminali, Divani componibili, Chaise longue, Pouf

Caratteristiche tecniche

Struttura base: Metallo verniciato a fuoco, telaio in legno multistrato.

Struttura schienale/bracciolo: Massello di abete e legni composti.

Molle: Nastri elastici unidirezionali ad alta portata.

Imbottitura base e schienale: Poliuretano espanso a quote differenziate, ricoperto in termofalda.

Cuscino seduta: In poliuretano espanso a quote differenziate ricoperto in termolegato cotone 100%.

Cuscini schienale: In fibra poliestere siliconata ricoperta da fodera in cotone 100%.

Piedi: in metallo verniciato colore RAL 7021 grigio nerastro.

Rivestimento: Rivestimento in tessuto o in pelle. Rivestimento in tessuto completamente sfoderabile.

Note particolari

Nelle composizioni è necessario il disegno.

EN_Product description

Sofas, End Elements, Unit sofas, Chaise longue, Ottoman

Technical features

Frame base: Baked varnished metal, multi-layer frame.

Frame backrest/arm: Solid fir-wood and composite woods

Springing: High resistance unidirectional elastic bands.

Base and backrest padding: Polyurethane foam with different densities covered with heated bonded polyester fibre.

Seat cushion: In differentiated-density polyurethane foam covered in 100% thermo-bonded cotton.

Back cushions: Silicone polyester fibre covered with 100% cotton lining.

Feet: Varnished metal RAL 7021 black grey.

Cover: Fabric or leather cover.

Fabric cover completely removable

Special notes

For compositions, please supply the drawing.

Piedi / Feet



*_metallo verniciato brunito
_burnished metal*

Vibieffe

SINCE 1968

contact@vibieffe.com www.vibieffe.com

310_IDENTITY

design: Gianluigi Landoni

- A - Memory foam / Memory foam
- B - Espanso densità portante / Foam supporting density
- C - Espanso densità soft / Foam soft density
- F - Telaio in ferro / Iron frame
- L - Fusto in legno / Wooden frame
- R - Resinato / Heated bonded polyester fibre
- S - Fibra poliestere siliconata / Silicon polyester fibre

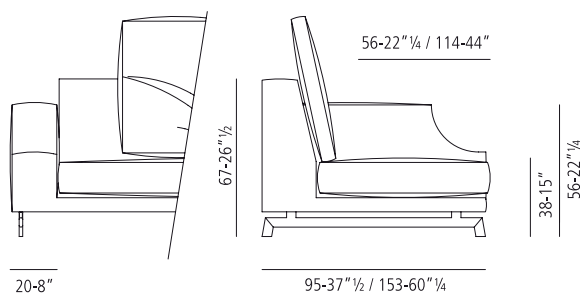
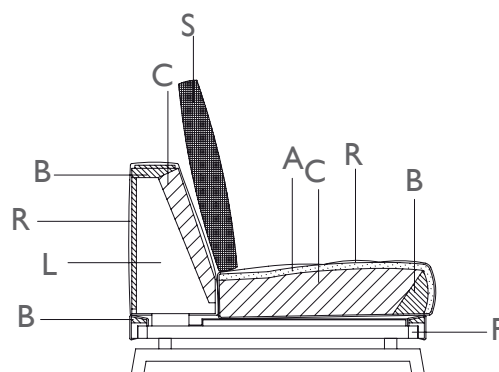

Vibieffe

SINCE 1968

contact@vibieffe.com www.vibieffe.com

310_IDENTITY

design: Gianluigi Landoni

cod. 310001

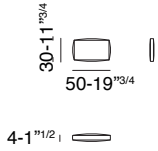

cod. 310002

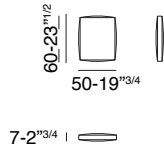

cod. 310003

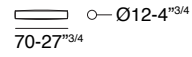

cod. 310004

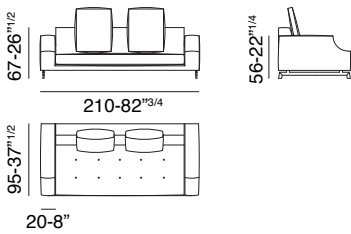

cod. 310005

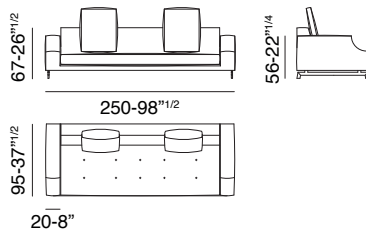

cod. 310006

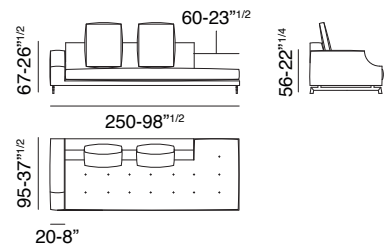

cod. 310007

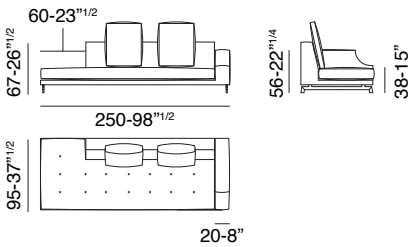

cod. 310008

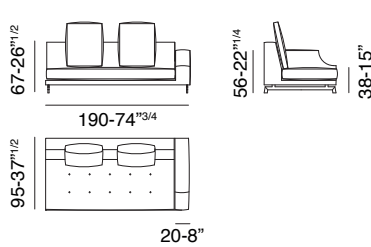

cod. 310009

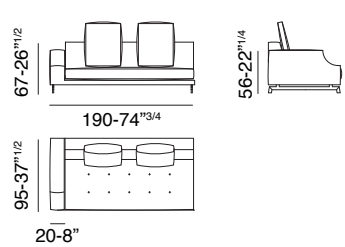

cod. 310010

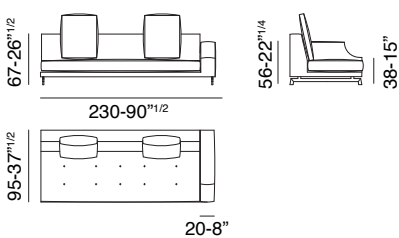

cod. 310011

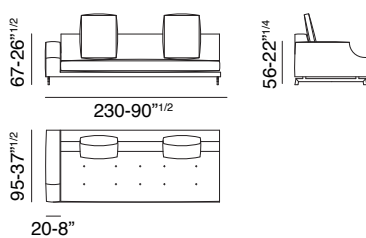

cod. 310012

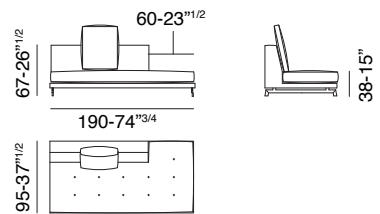

Vibieffe

SINCE 1968

contact@vibieffe.com www.vibieffe.com

310_IDENTITY

design: Gianluigi Landoni

cod. 310013

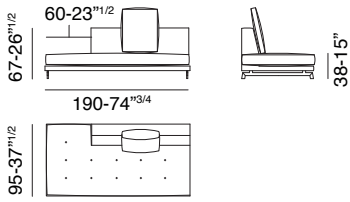

cod. 310014

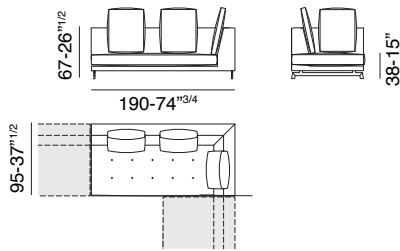

cod. 310015

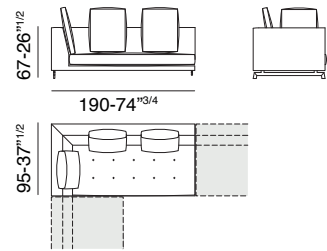

cod. 310016

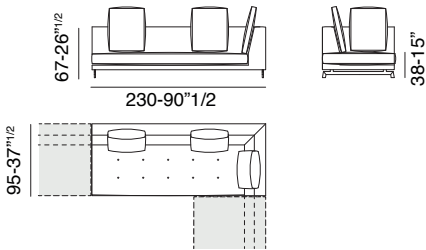

cod. 310017

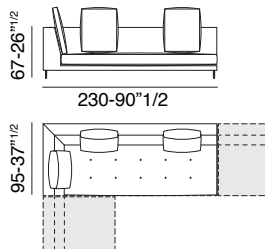

cod. 310018

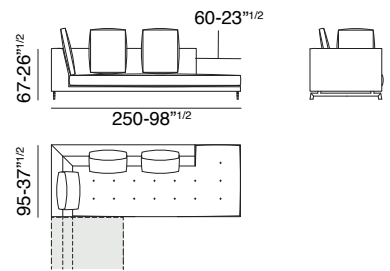

cod. 310019

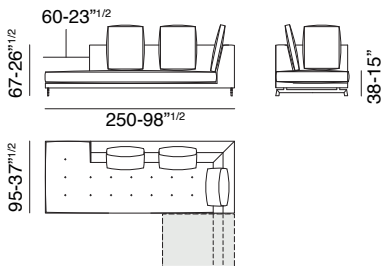

cod. 310020

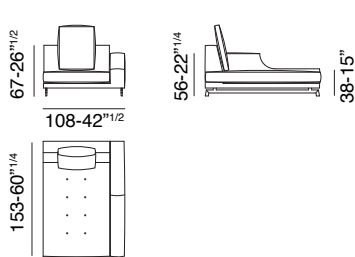

cod. 310021

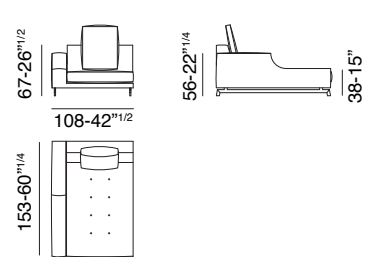

cod. 310022

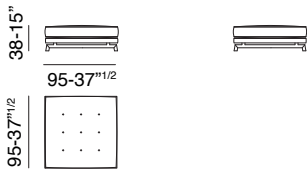

Vibieffe

SINCE 1968

contact@vibieffe.com www.vibieffe.com

310_IDENTITY

design: Gianluigi Landoni

