

BEL-AIR design_altrodesign

2800



IT Descrizione prodotto
Divano letto

EN Description of the product
Bed sofas

Caratteristiche Tecniche

Technical features

Struttura: legni compositi e multistrato
Imbottitura: poliuretano espanso ricoperto in termofalda
Cuscini seduta: poliuretano espanso ricoperto in termofalda
Cuscini schienale: piuma lavata e sterilizzata mista a fibra poliestere siliconata
Piedini: alluminio lucido
Accessorio: Vano contenitore per chaise longue
Rivestimento: rivestimento in tessuto o in pelle
 Rivestimento in tessuto completamente sfoderabile
Struttura meccanismo: acciaio ad alta resistenza. Verniciatura a forno con polveri epossidiche
Piano letto: ortopedico con rete elettrosaldata. Sedute con cinghie elastiche. Materasso in poliuretano espanso h. cm. 13x190

Frame: Composite woods and multilayer
Padding: Polyurethane foam covered with heated bonded polyester fibre
Seat cushions: Polyurethane foam covered with heated bonded polyester fibre
Back cushions: Sterilized and washed feather mixed with silicone polyester fibre
Feet: Bright aluminium
Cover: Fabric or leather cover. Fabric cover completely removable.
Accessory: Container for Chaise longue
Mechanism: Front open and lift
Mechanism frame: Highly resistant steel. Furnace painted with epoxy powders
Bed base: Orthopedic, electro-welded bed springs. Seat base with elastic belts.
 Polyurethane foam mattress cm. 13x190

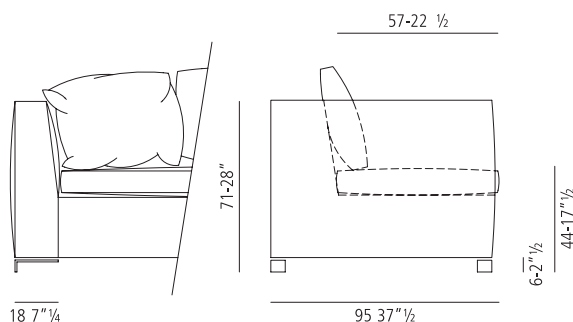

2800

_cod 2800001

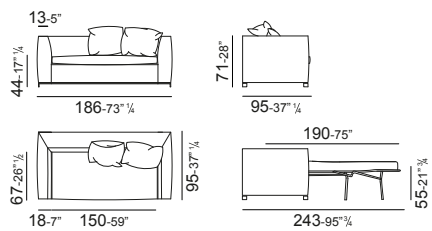

_cod 2800002

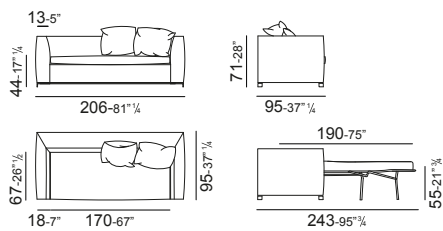

_cod 2800003

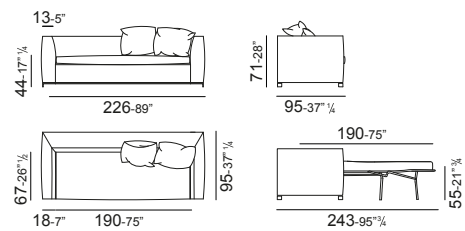

_cod 2800004/005

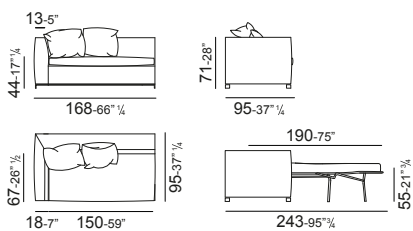

_cod 2800006/007

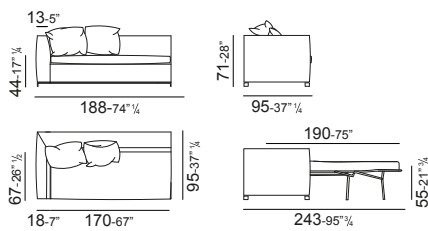

_cod 2800008/009

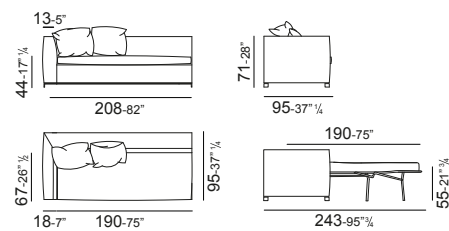

_cod 2800010/011

